



orbital

cutting.
beveling.
welding.

› complete solutions.
one source.

› 03/2012

Catalogue

EN



precision.
power.
simplicity.



New products.

GF 4 and GF 6 (AVM/MVM) | Pipe Cutting and Beveling Machines

The new GF series sets new standards in orbital pipe machining! Numerous innovative functions combined with an ergonomic design create significant advantages for you in the industrial prefabrication of pipeline systems.

Advantages:

- Anthracite-colored coated components for improved sliding properties and protection against corrosion
- Reduced operator impact by optional feed module AVM or MVM for an automated or manual cutting process

...more on page 5

GFX 3.0 | Pipe Cutting and Beveling Machines

New, innovative saw from Orbitalum Tools for cutting and beveling of tubes and elbows in just seconds. The perfect preparation for orbital welding!

Advantages:

- Square, burr-free and cold machining process
- Deformation-free clamping system especially applicable for thin-walled tubes
- Easy handling through light weight
- Simultaneous or separate cutting and beveling

...more on page 15

BRB 2 and BRB 4 | Boiler Pipe Preparation Machines

Powerful and robust Boiler Prep Machine. Counterboring and axial turning of pipes made from high-alloy steel (stainless steel), low-alloy and carbon steel with the unique tool system QTC®.

Advantages:

- Handy and compact design
- Precise and reproducible weld preparation
- Fast application with the BRB Pneumatic/Auto by means of pneumatic clamping, ideal for continuous production e.g. boiler and heat exchanger applications

...more on page 50

Order hotline: +49 (0) 77 31 792-0

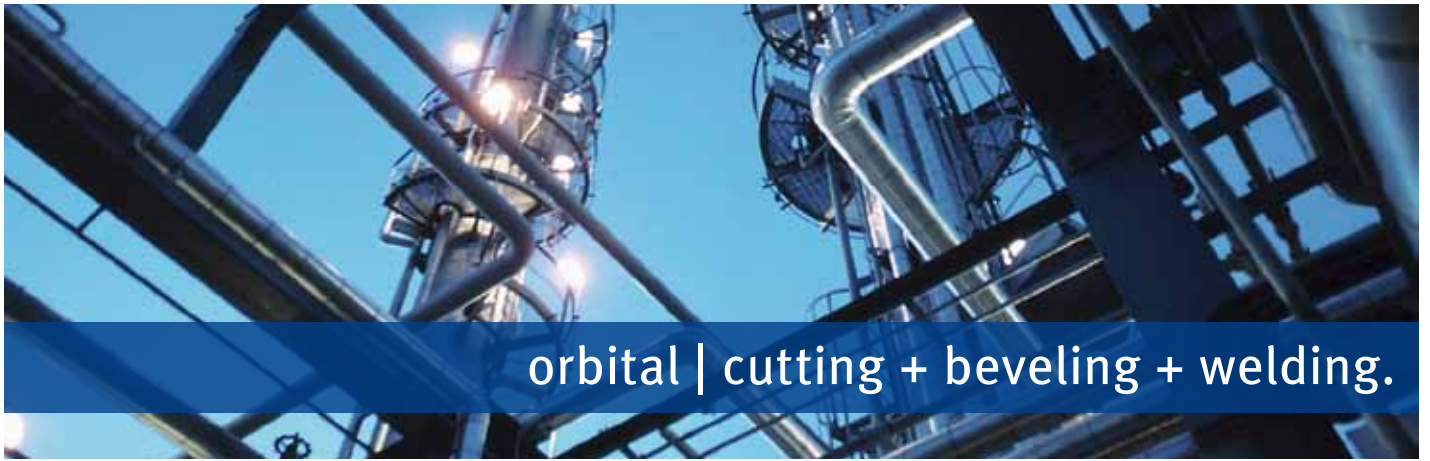

orbital | cutting + beveling + welding.

Pipe Cutting and Beveling Technology

Pipe Cutting and Beveling Machines

GF 4, GF 6 (AVM/MVM)..... 5

Pipe Cutting and Beveling Machines

RA 2, RA 8 and RA 12..... 8

Pipe Cutting and Beveling Machine GF 20 AVM 11

Lifting bench 13

Extension unit 13

Continuous cooling system 14

Aluminum clamping shells 14

Pipe Cutting and Beveling Machines GFX 3.0.....15

Set of stainless steel caps 17

Quick-mounting base plates 17

Durable storage and shipping case..... 17

RA Pipe Cutting and Beveling Machines RA 41 Plus18

Accessories for GF and RA machines20

Aluminum clamping shells 21

Special stainless steel clamping jaws 22

Set of stainless steel clamping attachments 22

Continuous cooling system 22

Saw blade lubricant GF TOP 22

Saw blade lubricant GF LUB 22

Special gear oil..... 22

Intermediate gearbox retrofit kit 23

Swivel cable 23

Quick-mounting base plates 23

Pipe feeder base unit and extension unit..... 24

Mobile Workstation.....25

Saw blades and bevel cutters for

GF and RA machines26

Saw blades..... 27

Saw blade/bevel cutter combinations 28

Weld-prep saw blade/bevel cutter combinations 28

Support disc for saw blade/bevel cutter

combinations..... 28

Press fitting saw blade/bevel cutter combinations 28

Bevel cutters 29

Saw blade lubricant GF TOP 29

Saw blade lubricant GF LUB 29

Portable Tube Saws PS 4.5, PS 6.6..... 30

Quick-mounting plate with screw clamps 32

Saw blades..... 32

Tripod 32

Clamping jaws replacement set..... 32

Laser retrofitting kit..... 32

Universal Pipe Cutter SCORP 220 Plus, SCORP 360.....33

Saw blade TCT 35

Cutting blade Diamond 35

Saw blade Cermet 35

Metal Tube Cutter MRA.....37

Multi-roller cutting chains 38

Clamping shells 38

Tube Squaring Technology

Tube Squaring Machines RPG ONE (cordless),

RPG 1.5 (cordless), RPG 2.5 (cordless).....39

Angle drive RPG ONE and RPG 1.5 (cordless) 41

One-piece stainless steel clamping shells..... 42

Adapter clamping shell for RPG 2.5..... 44

Tool holder WH 44

Multifunctional tool MFW..... 44

Tube Squaring Machines RPG 4.5, RPG 8.6.....45

Clamping shells 47

Tool holder WH 49

Multifunctional tool MFW..... 49



Complete solutions. One source.

Pipe Beveling Technology

Boiler Pipe Preparation Machines BRB	50
BRB with clamping system "Standard"	52
Retrofit kits BRB Standard "Dimension"	53
Retrofit kits BRB Standard "Pneumatic to Auto"	53
Retrofit kits BRB "Standard to NC"	54
BRB 4 with clamping system "NC"	55
Retrofit kits BRB 4 NC "Dimension"	56
Retrofit kits BRB NC "Pneumatic to Auto"	56
Brush attachments.....	57
Initial equipment kit of brushes for BRB 4	57
Hoist bracket	58
Bevel cutter heads	58
Adjustable spacer	59

Pipe End Preparation Machines REB 6, REB 14, REB 20	60
--	-----------

Accessories for BRB- and REB machines	63
Tool holder WH	64
Multifunctional tool MFW "Economy"	65
Multifunctional tool MFW "High-Performance"	65
Mobile air unit DWE 10	66
Air hose with quick coupling	66
Cutting lubrication KSS-TOP	66
Elbow clamping system	66
Optional clamping wedges.....	67
Plastic (POM) clamping shell segments	67
ID tracking for REB 14 and REB 20	68
Combination possibilities of tool holder WH and multifunctional tools MFW for REB and BRB machines	69

Tungsten Grinding Technology

Tungsten Grinder ESG Plus, ESG Plus²	72
Diamond grinding wheels	74
Cutting device.....	74
Electrode holder	74
Clamping collet.....	74

Wall-/table-/vice-mounting plate	75
Protective cover	75
Double-Decker Kit	75

Threading, Jointing and Sealing Technology

Accessories for Pipe Threading Technology	76
Automatic quick-change die-heads ASK	77
Replacement sets of threading chasers.....	77
Nipple holder	78
Thread cutting compound SPN PARALIQ® PLUS.....	78
Thread cutting compound NORMOLIC Red®	78

Thread Jointing Technology	79
Thread jointing compound PARALIQ® PM 35	79
Thread sealing tape PARALIQ® PM 35	79
Flax dispenser	79
Flax bobbin pocket dispenser	79

Seals	80
Seal dispenser	80
Seals for seal dispenser	80

Copper Pipe Installation Technology

Accessories for LAM 1500, LAM 1600	82
Clamp holder with carbon V-electrode	82
Carbon V-electrode	82
Stick electrode	82
Heating tongs with cable	82

Cleaning brushes and calibrating tools	83
---	-----------

Accessories for Workshop and Site

Work benches	85
Tool box	85
Pipe vices.....	85
Deburring tool	85

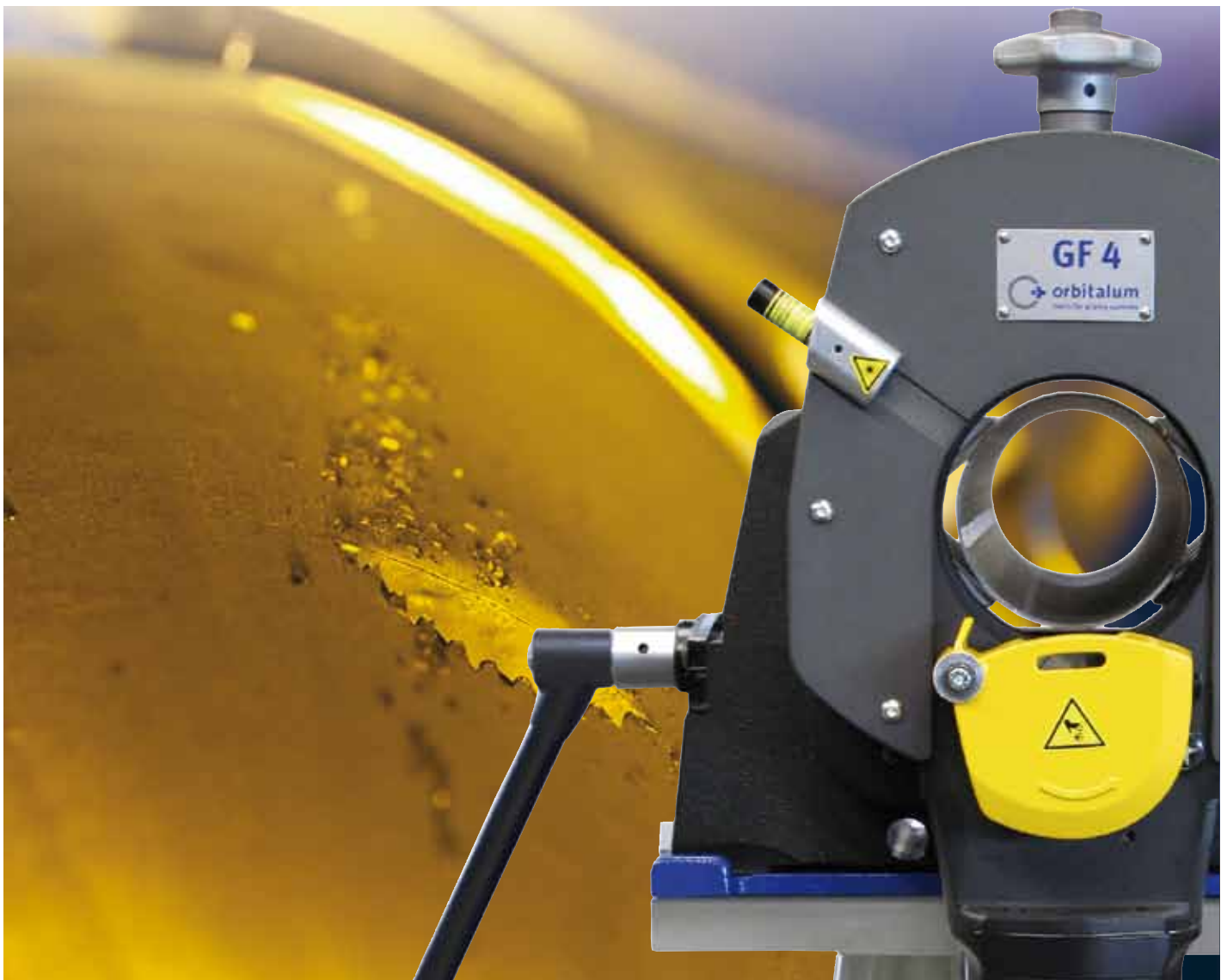

The GF series sets new standards in orbital tube and pipe machining!



Also available with automatic or manual feed modules AVM/MVM



Multifunctional wrench.
1 tool = 6 functions:
Vice handle, fastening clamping jaws, saw blades/bevel cutters, and quick mounting plate; anti-theft protection as well as blade adjustment with the star handle



2 position clamping jaws to enable the machining of thin-walled tubes



Integrated line laser to determine the cut off point

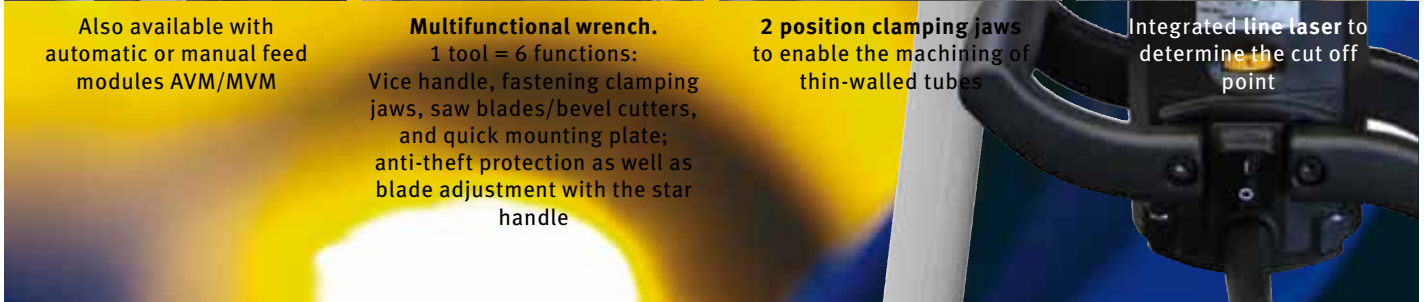

Pipe Cutting and Beveling Machines GF 5

GF Pipe Cutting and Beveling Machines

- Square, burr-free and cold machining process
- Deformation-free clamping system for tubes and pipes
- Optimum preparation for the automated welding process
- Sturdy design with powerful drive
- Unique and automated orbital cutting process
- Simultaneous or separate cutting and beveling
- Cost-effective, increasing productivity
- Even longer tool life



GF 4



GF 4 AVM



GF 4 MVM

GF 4, GF 6 (AVM/MVM)

The new GF series sets new standards in orbital pipe machining.

Numerous innovative functions combined with an ergonomic design create significant advantages for you in the industrial prefabrication of pipeline systems. Cutting and beveling high-alloy steel (stainless steel), low- and unalloyed steel, plastics, casting materials and non-ferrous metals in just seconds, using the “Planetary Cutting” method.

- Anthracite-colored coated components for improved sliding properties and protection against corrosion
- Stainless steel clamping attachments (Code 790 142 241) for protection against contact corrosion included
- Reduced operator impact by optional feed module AVM or MVM for an automated or manual cutting process
- Locking mechanism prevents unauthorized usage and theft
- A new ergonomically-designed motor handle for a safe and comfortable operating position, which also enables easy cutting of elbows
- Integrated line laser to determine the cut off point
- 2 position clamping jaws to reduce chatter and enable smaller length of pipe to be machined
- 1 multifunctional tool for all adjustments on the machine
- Extended speed range (65 - 215 rpm), ideal for the cutting of high-performance materials (Hastelloy®, P91, etc.)
- Swivel cable with a quick-disconnect coupler for easy and quick replacement of power cables
- The new chip guard protects against flying chips and comes with a measuring port (for GF 4 only)

Feed versions:

GF AVM*

Pipe Cutting and Beveling Machine with automatic feed module AVM. This intelligent solution continuously controls the cutting speed depending on the torque and the parameter settings. The AVM improves the handling of the GF and RA machine and stops automatically after the cutting process. The restart inhibit does not allow an unintended start-up.

GF MVM*

Pipe Cutting and Beveling Machines with manual feed module MVM. This manually operated feed module facilitates the cutting and beveling of pipes. With the help of a hand wheel, the machine head rotates easily and with little effort around the pipe with a constant speed.

Machine comes with:

- 1 Pipe Cutting and Beveling Machine GF 4 or GF 6 (AVM/MVM)*
- 1 Transportation case
- 1 Saw blade (GF 4: Code 790 042 064, GF 6: Code 790 043 018)
- 1 Set of stainless steel clamping attachments

- 1 Mounting plate
- 1 Tool set
- 1 Tube of saw blade lubricant GF TOP (Code 790 060 228)
- 1 Bottle of special gear oil (Code 790 041 030)
- 1 Set of operating instructions and spare parts list

* The automatic/manual feed module AVM/MVM is already fitted to the pipe cutter upon delivery

All saws are fitted with the quick disconnect swivel cable.



GF 6



GF 6 AVM



GF 6 MVM

Application range	GF 4 (AVM/MVM)	GF 6 (AVM/MVM)
Pipe OD	12 - 120 mm 0.472 - 4.724 inch	21.3 - 168.3 mm 0.839 - 6.626 inch
Wall thickness (depends on material)*	1 - 9 mm 0.039 - 0.354 inch	1.5 - 15 mm 0.059 - 0.591 inch
Pipe ID min. (saw blade Ø 63 mm/Ø 2.480 inch)	21 mm 0.827 inch	30 mm 1.181 inch
Pipe ID min. (saw blade Ø 68 mm/2.677 inch)	16 mm 0.630 inch	25 mm 0.984 inch
Pipe ID min. (saw blade Ø 80 mm/3.150 inch)	4 mm 0.157 inch	13 mm 0.512 inch
Pipe ID min. (saw blade Ø 100 mm/3.937 inch)	-	0 mm 0 inch
Technical data	Drive with single-phase AC motor	
Power	1.8 kW without AVM / 1.9 kW with AVM	
Built-in electronic variable cutting speed with restart inhibitor	65 - 215 rpm	65 - 215 rpm
Protection class	Double-insulated according to class II, DIN EN 60745-1 Double-insulated according to class I, DIN EN 60204-1 (GF AVM)	
Noise level at the workplace approx.	79 dB (A)	79 dB (A)
Vibration level	< 2.5 m/s ² in accordance with DIN EN 28662, part 1	

* Increased wall thickness possible with manual feed or by adding an additional cut (depending on the saw blade diameter).

Article	Version	Code	Weight of machine kg	Dispatch weight kg
GF 4	230 V, 50/60 Hz EU	790 142 001	61.300	88.000
GF 4	120 V, 50/60 Hz EU/US	790 142 002	61.300	88.000
GF 4 AVM	230 V, 50/60 Hz EU	790 142 011	70.500	98.000
GF 4 AVM	120 V, 50/60 Hz EU/US	790 142 012	70.500	98.000
GF 4 MVM	230 V, 50/60 Hz EU	790 142 021	66.600	98.000
GF 4 MVM	120 V, 50/60 Hz EU/US	790 142 022	66.600	98.000
GF 6	230 V, 50/60 Hz EU	790 143 001	92.700	140.000
GF 6	120 V, 50/60 Hz EU/US	790 143 002	92.700	140.000
GF 6 AVM	230 V, 50/60 Hz EU	790 143 011	101.700	153.000
GF 6 AVM	120 V, 50/60 Hz EU/US	790 143 012	101.700	153.000
GF 6 MVM	230 V, 50/60 Hz EU	790 143 021	97.800	147.000
GF 6 MVM	120 V, 50/60 Hz EU/US	790 143 022	97.800	147.000

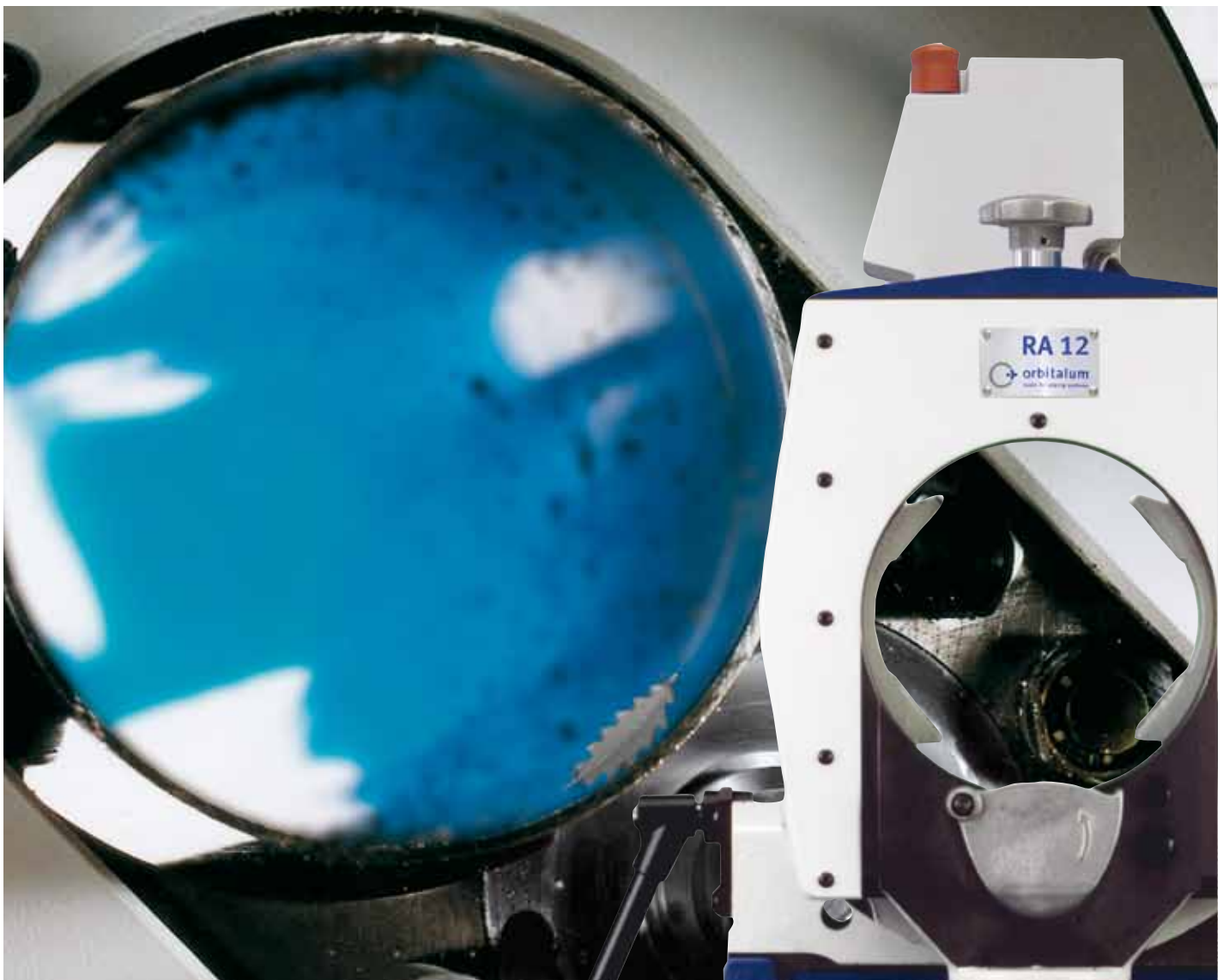

Perform economical cutting and beveling with technology made by Orbitalum Tools!

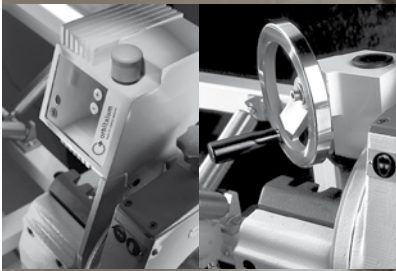

Also available with
automatic or manual feed
module AVM/MVM



New motor with
extended speed range



Planetary Cutting
Technology

8

Pipe Cutting and Beveling Machines RA

RA Pipe Cutting and Beveling Machines

- Square, burr-free and cold machining process
- Deformation-free clamping system for tubes and pipes
- Optimum preparation for the automated welding process
- Sturdy design with powerful drive
- Unique and automated orbital cutting process

RA 2, RA 8 and RA 12

Cutting and beveling high-alloy steel (stainless steel), low- and unalloyed steel, plastics, casting materials and non-ferrous metals in just seconds, using the “Planetary Cutting” method.

- Reduced operator impact by optional feed module AVM or MVM for an automated or manual cutting process
- Multiple point clamping
- Fast adjustment of dimensions
- Regulated cutting speed
- Optimal tool contact
- Working direction from the inside towards the outside
- Fast tool replacement
- Optimal speed range of 65 - 215 rpm, ideal for the cutting of high-performance materials (Hastelloy®, P91, etc.)
- An ergonomically-designed motor handle for a safe and comfortable operating position
- Square, burr-free and deformation-free pipe end
- Cold machining process
- Cutting in seconds
- Simultaneous or separate cutting and beveling
- Increased productivity
- Improved cutting quality
- Increased service life of tools

Pipe Cutting and Beveling Machines **with special aluminum attachments**. Supplied as standard with RA 8 and RA 12.

The above-mentioned RA machines are also available in the following **feed versions**:

RA 8 AVM and RA 12 AVM

Pipe Cutting and Beveling Machines **with integrated crown wheel and automatic feed module AVMAVM**. This intelligent solution continuously controls the cutting speed depending on the torque and the parameter settings. The AVM improves the handling of the GF and RA machine and stops automatically after the cutting process. The restart inhibit does not allow an unintended start-up.

RA 8 MVM and RA 12 MVM

Pipe Cutting and Beveling Machines **with manual feed module MVM**. This manually operated feed module facilitates the cutting and beveling of pipes. With the help of a hand wheel, the machine head rotates easily and with little effort around the pipe with a constant speed.

Machine comes with:

- 1 Pipe Cutting and Beveling Machine RA (AVM/MVM)*
- 1 Transportation case
- 1 Saw blade (RA 2: Code 790 041 035, RA 8: Code 790 043 018, RA 12: Code 790 043 018)
- 1 Mounting plate
- 1 Tool set



RA 2



RA 8, RA 8 AVM, RA 8 MVM



RA 12, RA 12 AVM, RA 12 MVM

- 1 Tube of saw blade lubricant GF TOP (Code 790 060 228)
- 1 Bottle of special gear oil (Code 790 041 030)
- 1 Set of operating instructions and spare parts list

All RA's are fitted with the swivel cable with a quick-disconnect coupler.

Application range		RA 2	RA 8 (AVM/MVM)	RA 12 (AVM/MVM)
Pipe OD	[mm]	12 - 63	114 - 230	154 - 325
	[inch]	0.472 - 2.480	4.488 - 9.055	6.063 - 12.795
Wall thickness depends on material**	[mm]	1.5 - 5.5	2 - 10	2 - 10
	[inch]	0.059 - 0.217	0.079 - 0.394	0.079 - 0.394
Pipe ID min. (saw blade-Ø 63 mm/2.480 inch)	[mm]	7	137	190
	[inch]	0.276	5.394	7.480
Pipe ID min. (saw blade-Ø 68 mm/2.677 inch)	[mm]	2	132	185
	[inch]	0.079	5.197	7.283
Pipe ID min. (saw blade-Ø 80 mm/3.150 inch)	[mm]	-	120	173
	[inch]	-	4.724	6.811
Pipe ID min. (saw blade-Ø 100 mm/3.937 inch)	[mm]	-	100	153
	[inch]	-	3.937	6.024
Technical data		Drive with single-phase AC motor		
Dimensions (lxwxh) RA	[mm]	620 x 350 x 420	778 x 485 x 430	940 x 592 x 374
	[inch]	24.4 x 13.8 x 16.5	30.6 x 19.1 x 16.9	37.0 x 23.3 x 14.7
Dimensions (lxwxh) RA AVM	[mm]	-	918 x 485 x 430	1.070 x 592 x 374
	[inch]	-	36.1 x 19.1 x 16.9	42.1 x 23.3 x 14.7
Dimensions (lxwxh) RA MVM	[mm]	-	788 x 485 x 430	1.090 x 592 x 374
	[inch]	-	31.0 x 19.1 x 16.9	42.9 x 23.3 x 14.7
Power RA / RA AVM / RA MVM	[kW]	1.8 / - / -	1.8 / 1.9 / 1.8	1.8 / 1.9 / 1.8
Power AVM	[kW]	-	0.10	0.10
Protection class	[class]	Double-insulated according to class II, DIN EN 60745-1 (RA AVM: according to class I, EN 60204-1)		
Built-in electronic speed regulation with speed stabilisation	[rpm]	65 - 215	65 - 215	65 - 215
Vibration level in accordance with 28662, part 1	[m/s²]	< 2.5	< 2.5	< 2.5
Noise level at the workplace approx.	[dB (A)]	79	79	79

Article	Version	Code		Weight of machine kg	Dispatch weight kg
RA 2	230 V, 50/60 Hz EU	790 041 095		41.000	60.000
RA 2	120 V, 50/60 Hz EU/US	790 041 096		41.000	60.000
RA 2 INOX	230 V, 50/60 Hz EU	790 041 057		41.000	62.000
RA 2 INOX	120 V, 50/60 Hz EU/US	790 041 090		41.000	62.000
RA 8	230 V, 50/60 Hz EU	790 045 095		102.000	149.000
RA 8	120 V, 50/60 Hz EU/US	790 045 096		102.000	149.000
RA 8 AVM	230 V, 50/60 Hz EU	790 045 001		114.000	165.000
RA 8 AVM	120 V, 50/60 Hz EU/US	790 045 007		114.000	165.000
RA 8 MVM	230 V, 50/60 Hz EU	790 045 069		103.000	153.000
RA 8 MVM	120 V, 50/60 Hz EU/US	790 045 082		103.000	153.000
RA 12	230 V, 50/60 Hz EU	790 047 095		135.000	177.000
RA 12	120 V, 50/60 Hz EU/US	790 047 096		135.000	177.000
RA 12 AVM	230 V, 50/60 Hz EU	790 047 001		146.000	205.000
RA 12 AVM	120 V, 50/60 Hz EU/US	790 047 007		146.000	205.000
RA 12 MVM	230 V, 50/60 Hz EU	790 047 069		139.000	200.000
RA 12 MVM	120 V, 50/60 Hz EU/US	790 047 082		139.000	200.000

* The automatic/manual feed module AVM/MVM is already fitted to the pipe cutter upon delivery

** Increased wall thickness possible with manual feed or by adding an additional cut (depending on the saw blade diameter).
When processing thin-walled tubes, special clamping shells may be needed, see page 21.



A strong machine for demanding applications!



Unique automatic process by the AVM feed module thus ensuring constant cutting

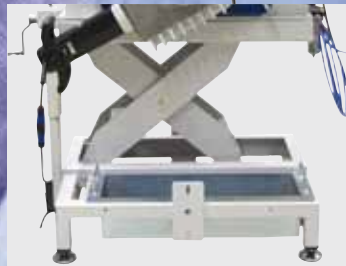

Including a height-adjustable and robust lifting bench with a container for swarf collection



An even higher operating life of the tools is guaranteed by the continual cooling system (available as special accessory)

Pipe Cutting and Beveling Machine GF 20 AVM

GF Pipe Cutting and Beveling Machine

- Square, burr-free and cold machining process
- Optimum preparation for the automated welding process
- Sturdy design with powerful drive
- Unique and automated orbital cutting process
- Height-adjustable lifting bench

GF 20 AVM

Pipe Cutting and Beveling Machine **with automatic feed module AVM***. This intelligent solution continuously controls the cutting speed depending on the torque and the parameter settings. The AVM improves the handling of the GF and RA machine and stops automatically after the cutting process. The restart inhibit does not allow an unintended start-up. Cutting and beveling high-alloy steel (stainless steel), low- and unalloyed steel, plastics, casting materials and non-ferrous metals in just seconds, using the “Planetary Cutting” method.

- Reduced operator impact by optional feed module AVM or MVM for an automated or manual cutting process
- A new ergonomically-designed motor handle for a safe and comfortable operating position, which also enables easy cutting of elbows
- 1 multifunctional tool for all adjustments on the machine
- High rotational moment for optimal cutting and beveling processes
- Optimal speed range of 50 - 163 rpm, ideal for cutting high-performance materials (Hastelloy®, P91, etc.)
- Plug connection with quick-action coupling: for easy and comfortable replacement of the power cable
- Optimized saw blade guard protects the user against flying chips

Machine comes with:

- 1 Pipe Cutting and Beveling Machine GF 20 AVM*
- 1 Transportation case
- 1 Lifting bench (Code 790 050 051)
- 1 Saw blade (Code 790 047 026)
- 1 Tool set
- 1 KSS-TOP lubricant spray pump (Code 790 060 226)
- 1 Tube of saw blade lubricant GF TOP (Code 790 060 228)
- 1 Bottle of special gear oil (Code 790 041 030)
- 1 Set of operating instructions and spare parts list

* The automatic feed module AVM is already fitted to the pipe cutter upon delivery.

The saw is fitted with the swivel cable with a quick-disconnect coupler.

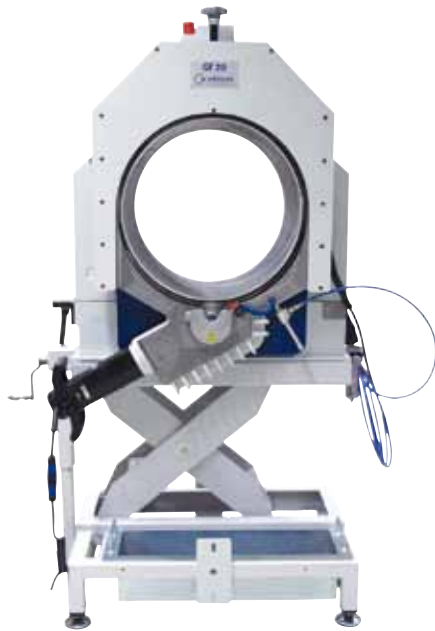

GF 20 AVM with lifting bench

Application range	GF 20 AVM
Pipe OD	283 - 508 mm / 11.14 - 20 inch
Pipe ID min. (saw blade Ø 80 mm/3.150 inch)	295 mm / 11.6 inch
Pipe ID min. (saw blade Ø 100 mm/3.937 inch)	275 mm / 10.8 inch
Wall thickness max.	15 mm / 0.59 inch
Pipe materials	Steel, stainless steel, copper, cast, iron, aluminum, synthetic
Technical data	Drive with single-phase AC motor
Dimensions of GF 20 incl. lifting bench (hxwx) approx.	145 - 171 x 94 x 63 cm / 57.1 - 67.3 x 37 x 24.8 inch
Dimensions of lifting bench (hxwx) approx.	44.5 - 70.5 x 94 x 63 cm / 17.5 - 27.8 x 37 x 24.8 inch
Load capacity of lifting bench max.	1.200 kg / 2,645.5 lbs
Power	1.9 kW (AVM: 50 W)
Built-in electronic variable cutting speed with restart inhibitor	50 - 163 rpm

Application range	GF 20 AVM
Protection class	Protection isolated class I, DIN VDE 0740
Vibration level in accordance with 28662, part 1	2.5 m/s ²
Noise level at the workplace	approx. 79 dB (A)

Article	Version	Code	Weight of machine* kg	Dispatch weight kg
GF 20 AVM	230 V, 50/60 Hz EU	790 050 001	475.000	554.000
GF 20 AVM	120 V, 50/60 Hz EU/US	790 050 002	475.000	554.000

* Weight including lifting bench

Lifting bench

For GF 20 AVM (supplied as standard) and RA 12. Easy mounting of the saw directly on to the plate. On the RA 12, fastening with quick-mounting plate only. Mechanical height adjustment using a handwheel. Very sturdy and robust design with steel construction. Swarf collector included.

Technical data	Lifting bench for GF 20 AVM and RA 12
Dimensions of lifting bench (h x w x d) approx.	44.5 - 70.5 x 94 x 63 cm / 17.5 - 27.8 x 37 x 24.8 inch
Load max.	1,200 kg / 2,645.52 lbs

Article	Code	kg
Lifting bench for GF 20 AVM and RA 12	790 050 051	170.000



Lifting bench

Extension unit

For GF 20 AVM. Available as an accessory. The extension unit accurately feeds long and heavy pipes into the pipe cutter. Very robust and sturdy design with 2 V supports and stainless steel bearings. Modular construction. Application with 2 extension units is recommended.

Application range	Extension unit
Pipe OD max.	508 mm / 20 inch
Dimensions approx.	110 x 50 x 95 cm / approx. 43.3 x 19.7 x 37.4 inch
Load capacity max.	400 kg / 881.8 lbs

Article	Code	kg
Extension unit for GF 20 AVM	790 050 061	67.000



Extension unit

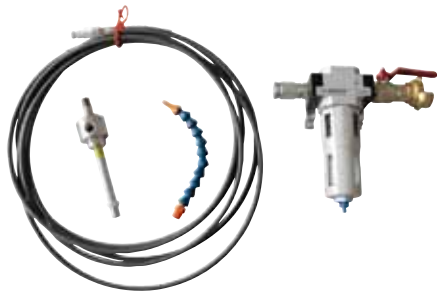

Continuous cooling system

Continuous cooling system

For GF 20 AVM. For GF 4, GF 6, RA 8 and RA 12 on request.

To increase the service life of the saw blade and for improved surface finish to the pipe. The system is cooled with compressed air fed through a vortex tube. The cooling air rate can be configured to the optimum level for your application. Also suitable for cutting plastic pipes. Cooling without coolants. The saw blade is constantly cooled during the cutting process with cold air (to -37 °C).

Article	Version	Code	kg
Continuous cooling system	Compressed air (5.5 - 8.0 bar required)	790 050 773	0.600



Aluminum clamping shells

Aluminum clamping shells

For GF 20 AVM. Ideal for clamping thin-walled pipes. When ordering, please indicate the outside diameter of the tube to be worked on.

Comes with:

- 4 Clamping shells
- 8 Cylinder head screws
- 8 Cylinder head pins

Article	Code	kg
Aluminum clamping shells for GF 20 AVM	on request	3.700



The perfect preparation for orbital welding!



Square, burr-free and deformation-free pipe end – ideal for pressfitting applications



Second saw blade position to cut off elbows



Powerful drive with electronic overload protection and ergonomically designed motor handle



Hardened cast iron clamping jaws – stainless steel caps optional available



Integrated line laser to mark the cut off point

Pipe Cutting and Beveling Machine GFX 3.0

GFX Pipe Cutting and Beveling Machines

- Square, burr-free and cold machining process
- Deformation-free clamping system especially applicable for thin-walled tubes
- Easy handling through light weight
- Simultaneous or separate cutting and beveling
- Increased productivity
- Low-maintenance and service friendly
- Environmentally friendly and long product life
- Second saw blade position to cut off elbows
- Ideal for pressfitting applications

GFX 3.0

New, innovative saw from Orbitalum Tools for cutting and beveling of tubes and elbows in just seconds. The perfect preparation for orbital welding! Easy to use, powerful and compact saw with low weight – our new GFX 3.0 provides even more outstanding features:

- Optimized chip flow due to a new vice design
- Hardened cast iron clamping jaws
- Integrated line laser to mark the cut off point
- Ergonomically designed motor handle
- Powerful drive with 1.2 kW and adjustable speed control for cutting several materials and extended tool life
- Electronic overload protection with integrated temperature monitor and electronic speed regulation
- Increased durability of tools due to the new drive GF10
- Ergonomically positioned speed control adjusting wheel
- Swivel cable with a quick-disconnect coupler for easy and quick replacement of power cables
- Directly mountable to the work bench

Machine comes with:

- 1 Pipe Cutting and Beveling Machine GFX 3.0
- 1 Transportation case
- 1 Saw blade (Code 790 041 035)
- 1 Tool set
- 1 Tube of saw blade lubricant GF TOP (Code 790 060 228)
- 1 Set of operating instructions and spare parts list



GFX 3.0



GFX 3.0

Application range	with tubes	with bars
Tube OD min.-max. (saw blade Ø 63 mm/2.480 inch)	6.0 - 78.0 mm 0.236 - 3.071 inch	6.0 - 16.0 mm 0.236 - 0.630 inch
Tube OD min.-max. (saw blade Ø 68 mm/2.677 inch)	6.0 - 73.0 mm 0.236 - 2.874 inch	6.0 - 21.0 mm 0.236 - 0.827 inch
Wall thickness min.-max. (saw blade Ø 63 mm/2.480 inch)	0.8 - 5.5 mm 0.032 - 0.217 inch	–
Wall thickness min.-max. (saw blade Ø 68 mm/2.677 inch)	0.8 - 7.0 mm 0.032 - 0.276 inch	–
Tube materials	Unalloyed, low-alloy and high-alloy steel, stainless steel, non-ferrous metal, aluminum alloy, titanium alloy, composite material and plastic	
Technical data	Electric drive with single-phase AC motor	
Dimensions (lxhxb)	570 x 280 x 330 mm / 22.441 x 11.024 x 12.993 inch	
Protection class	Class II	
Power	1200 W	
Built-in electronic speed regulation with speed stabilisation	30 - 200 rpm	
Vibration level in accordance with 50144	< 2.5 m/s ²	

Article	Version	Code	Weight of machine kg	Dispatch weight kg
GFX 3.0	230 V, 50/60 Hz EU	790 144 001	28.500	44.000
GFX 3.0	120 V, 50/60 Hz US	790 144 002	28.500	44.000

Accessories for GFX 3.0

Set of stainless steel caps

Ideal for preparing stainless steel tubes. Prevents contact corrosion between tube and clamping parts. Clamping shells for thin-walled tubes are available on request.

Set comes with:

- 6 Stainless steel caps
- 12 Countersunk screws
- 1 Allen key

Article	Code	kg
Set of stainless steel caps for GFX 3.0	790 144 200	0.150

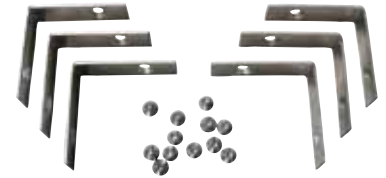

Set of stainless steel caps

Quick-mounting base plates

With and without integrated screw clamps for quick mounting of the machine on work benches, see page 23.

Durable storage and shipping case

High-quality padded blue shipping case.

Article	Code	kg
Durable storage and shipping case for GFX 3.0	790 144 019	12.500



Durable storage and shipping case



One machine to cut tubes and elbows!



Application



New motor with
extended speed range

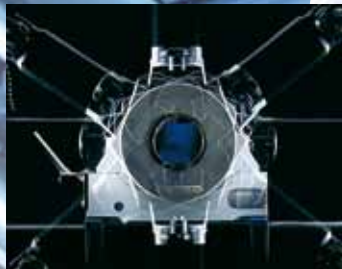

Planetary Cutting
Technology

RA Pipe Cutting and Beveling Machines

- Square, burr-free and cold machining process
- Deformation-free clamping system, especially applicable for thin-walled tubes
- Fast dimension adjustment
- Sturdy design with powerful drive
- Optimum preparation for the automated welding process
- Dimension related clamping shells made of aluminum for thin-walled tubes
- Clamping jaws made of aluminum

RA 41 Plus

Cutting and beveling pipes and elbows in high-alloy steel (stainless steel), low- and unalloyed steel, plastics, casting materials and non-ferrous metals in just seconds, using the "Planetary Cutting" method.

- Optimal speed range of 65 - 215 rpm, ideal for the cutting of high-performance materials (Hastelloy®, P91, etc.)
- An ergonomically-designed motor handle for a safe and comfortable operating position
- One machine to cut tubes and elbows
- Effective and environmental friendly
- Increased service life of tools
- No contact corrosion while preparing stainless steel tubes
- Perfect for INOX applications

Machine comes with:

- 1 Pipe Cutting and Beveling Machine RA 41 Plus
- 1 Transportation case
- 1 Saw blade (Code 790 042 064)
- 1 Set of aluminum clamping jaws (Code 790 046 250)
- 1 Mounting plate
- 1 Tool set
- 1 Tube of saw blade lubricant GF TOP (Code 790 060 228)
- 1 Bottle of special gear oil (Code 790 041 030)
- 1 Set of operating instructions and spare parts list



RA 41 Plus

Application range	RA 41 Plus
Pipe OD (tubes)	10 - 120 mm / 0.394 - 4.724 inch
Pipe OD (elbows)	30 - 120 mm / 1.181 - 4.724 inch
Wall thickness (depends on material)	0.6 - 7 mm / 0.024 - 0.276 inch
Tube ID min. (saw blade Ø 63 mm/2.480 inch)	21 mm / 0.827 inch
Tube ID min. (saw blade Ø 68 mm/2.677 inch)	16 mm / 0.630 inch
Tube ID min. (saw blade Ø 80 mm/3.150 inch)	4 mm / 0.157 inch
Tube materials	Unalloyed and low-alloyed steel, high-alloyed steel, copper, brass, annealed cast-iron pipe (nodular graphite iron), aluminum.
Technical data	Electric drive with single-phase AC motor
Dimensions	700 x 490 x 460 mm / 27.6 x 19.3 x 18.1 inch
Power	1.8 kW
Protection class	Double-insulated according to class II, DIN VDE 0740
Built-in electronic variable cutting speed with restart inhibitor	65 - 215 rpm
Vibration level	< 2.5 m/s ² (EN 28662, part 1)
Noise level at the workplace approx.	At idle: 76 dB (A), under load: 85 dB (A)

Article	Version	Code	Weight of machine kg	Dispatch weight kg
RA 41 Plus	230 V, 50/60 Hz EU	790 046 011	70.000	109.000
RA 41 Plus	120 V, 50/60 Hz EU	790 046 014	70.000	109.000
RA 41 Plus	120 V, 50/60 Hz US	790 046 012	70.000	109.000



For more efficiency and easy handling in the workplace!



Our high-performance lubricants for cutting and beveling to increase the tool life of saw blades (page 22)



Clamping shells or jaws for deformation- or corrosion-free clamping of tubes (page 21)



Quick-mounting base plates – ideal for frequent changes of location (page 23)



Pipe feeder for accurately feeding long and heavy pipes into GF and RA machines (page 24)

Our Mobile Workstation for the mobile site and/or workshop (page 25):



Lockable tool box with 4 drawers



Lifting table with height adjustment



Swarf collection tray



Roller pipe support

Accessories for GF and RA machines

Aluminum clamping shells

For RA 6, RA 8 and RA 12. Customized aluminum clamping shells for deformation-free clamping of thin-walled tubes.

When ordering, please indicate the outside diameter and/or inside diameter and the wall thickness of the tube to be worked on.

Comes with:

- 4 Cylinder head screws
- 1 Set of clamping shells

When ordering clamping shells for RA 8 you will also receive:

- 1 Drilling jig for the assembly of the clamping shells
- 2 Cylinder head screws for the drilling jig

Other dimensions are available.

Article	Version	Pipe OD [mm]	Pipe OD [inch]	Code	kg
Aluminum clamping shells	for RA 6	76.1	3.000	790 043 216	4.500
Aluminum clamping shells	for RA 6	122.5	4.823	790 043 220	3.800
Aluminum clamping shells	for RA 6	125.0	4.921	790 043 219	–
Aluminum clamping shells	for RA 6	148.5	5.846	790 043 221	3.300
Aluminum clamping shells	for RA 6	154.0	6.063	790 043 218	3.130
Aluminum clamping shells	for RA 6	177.5	6.988	790 043 222	2.600
Aluminum clamping shells	for RA 8	129.0	5.079	790 045 216	4.300
Aluminum clamping shells	for RA 8	139.1	5.476	790 045 219	4.700
Aluminum clamping shells	for RA 8	167.0	6.575	790 045 218	4.000
Aluminum clamping shells	for RA 8	168.3	6.626	790 045 220	3.600
Aluminum clamping shells	for RA 8	210.0	8.268	790 045 217	2.900
Aluminum clamping shells	for RA 8	219.1	8.626	790 045 222	–
Aluminum clamping shells	for RA 12	204.0	8.030	790 047 222	–
Aluminum clamping shells	for RA 12	209.0	8.230	790 047 221	11.500
Aluminum clamping shells	for RA 12	219.0	8.620	790 047 220	11.200
Aluminum clamping shells	for RA 12	254.0	10.000	790 047 216	9.200
Aluminum clamping shells	for RA 12	273.0	10.750	790 047 219	8.400
Aluminum clamping shells	for RA 12	300.0	11.810	790 047 224	9.100
Aluminum clamping shells	for RA 12	324.0	12.760	790 047 218	6.100
Aluminum clamping shells	for RA 12	306.0	12.047	790 047 225	5.800

Aluminum clamping shells for GF 4 and RA 41 Plus

For deformation-free clamping of thin-walled tubes.

Further clamping shells are available for various outer diameters.

Article	Tube OD [mm]	Tube OD [inch]	Code	kg
Aluminum clamping shells	25.40	1.000	790 046 316	3.025
Aluminum clamping shells	38.10	1.500	790 046 331	2.950
Aluminum clamping shells	50.80	2.000	790 046 345	2.850
Aluminum clamping shells	76.10	2.996	790 046 358	2.800
Aluminum clamping shells	88.90	3.500	790 046 363	2.500
Aluminum clamping shells	108.00	4.252	790 046 367	1.640
Aluminum clamping shells	114.30	4.500	790 046 368	1.640

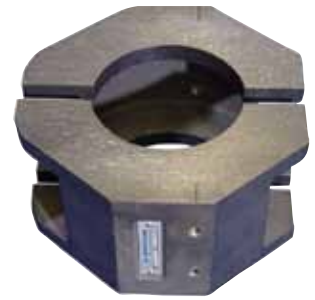

Aluminum clamping shells



Aluminum clamping shells for GF 4 and RA 41 Plus



Special stainless steel clamping jaws

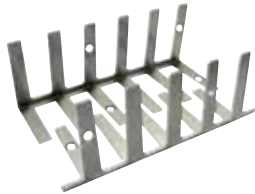

Set of stainless steel clamping attachments



GF TOP



GF LUB



Special gear oil

Special stainless steel clamping jaws for RA 2, RA 21 S, GF 4, RA 4 and RA 41 Plus

In pairs. Retrofit. While stock last.

Article	Code	kg
Special stainless steel clamping jaws for RA 2 and RA 21 S	790 041 323	1.035
Special stainless steel clamping jaws for GF 4, RA 4 and RA 41 Plus	790 042 201	2.350

Set of stainless steel clamping attachments

For GF 4 and GF 6 (AVM/MVM). For protection against contact erosion. Standard part of the GF 4 and the GF 6 (AVM/MVM).

Article	Version	Code	kg
Set of stainless steel clamping attachments for GF 4	right + left	790 142 241	0.510
Set of stainless steel clamping attachments for GF 6	right + left	790 143 200	0.510

Continuous cooling system

On request for GF 4, GF 6, RA 8 and RA 12 available. For details, see page 14.

Saw blade lubricant GF TOP

Synthetic high-performance lubricant for cutting and beveling machines. Increases the tool life of the saw blade. Compliant with the food approval NSF H2. The screwable brush guarantees an easy and uniform application of lubricant on the saw blade.

Article	Version	Code	kg
Saw blade lubricant GF TOP	Tube, 180 g	790 060 228	0.205

Saw blade lubricant GF LUB

The NEW chlorine-free high-performance lubricant for cutting and beveling. Increases the tool life of the saw blade. This ecologically cutting compound is the environmentally friendly replacement for ROCOL: just with a new name and improved quality. GF LUB meets the latest environmental directives and ecological standards.

Article	Version	Code	kg
Saw blade lubricant GF LUB	Tube, 160 ml	790 041 016	0.144

Special gear oil

For all GF and RA machines.

Article	Version	Code	kg
Special gear oil	Bottle, 250 ml	790 041 030	0.235

Intermediate gearbox retrofit kit

To convert a standard pipe cutting and beveling RA machine (RA) to RA H (with intermediate gear) with the former FE 680 Motor (150 - 270 rpm). The intermediate gearbox reduces the cutting speed of the RA machine to 40 - 70 rpm and increases torque. For cutting high-performance materials e.g. Hastelloy® and Inconel. Fits all RA 2, RA 4, RA 41, RA 41 Plus, RA 6, RA 8 and RA 12 machines. The kit includes all parts necessary for retrofitting as well as additional gear oil.



Intermediate gearbox retrofit kit

Article	Code	kg
Intermediate gearbox retrofit kit	790 041 063	2.000

Swivel cable

To prevent twisting of the cable. For all GF, RA and PS machines with protection class II (double insulated).

Article	Version	Cable length [m/ft]	Code	kg
Swivel cable complete	230 V, 50/60 Hz EU	4/13.1	790 142 081	0.560
Swivel cable complete	120 V, 50/60 Hz US/CA	4/13.1	790 142 082	0.560
Swivel cable complete	230 V, 50/60 Hz CH	4/13.1	790 142 083	0.560
Swivel cable complete	230 V, 50/60 Hz AU	4/13.1	790 142 084	0.560
Swivel cable complete	120 V, 50/60 Hz GB	4/13.1	790 142 087	0.560
Swivel cable	230 V, 50/60 Hz EU	4/13.1	790 142 076	0.560
Swivel cable	120 V, 50/60 Hz US/CA	4/13.1	790 142 077	0.560
Swivel cable	230 V, 50/60 Hz CH	4/13.1	790 142 078	0.560
Swivel cable	120 V, 50/60 Hz GB	4/13.1	790 142 079	0.560
Swivel cable	230 V, 50/60 Hz AU	4/13.1	790 142 080	0.560



Swivel cable



Swivel cable complete

Quick-mounting base plate without screw clamps

Complete with screws and nuts to mount the GFX 3.0 on a work bench.

Article	Code	kg
Quick-mounting base plate complete for GFX 3.0, RA 2 (H), RA 21 S	790 041 026	2.380

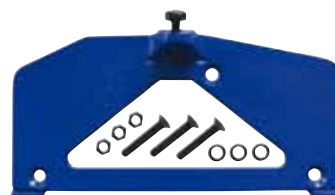

Quick-mounting base plate without screw clamps

Quick-mounting base plates with integrated screw clamps

For quick mounting of the machine on work benches. Ideal for frequent changes of location.

Article	Code	kg
Quick-mounting base plate for GFX 3.0, RA 2 (H), RA 21 S	790 041 027	4.230
Quick-mounting base plate for GF 4, RA 4 (H), RA 6 (H), RA 8 (H), RA 41 Plus (H)	790 042 027	6.165
Quick-mounting base plate for PS 4.5 and PS 6.6	790 048 334	2.600



Quick-mounting base plates with integrated screw clamps

Pipe feeder base unit and extension unit

The pipe feeder accurately feeds long and heavy pipes into GF and RA machines. Very sturdy and stable design with powder-coated frames and stainless steel rollers.

Advantages:

- Extremely stable and sturdy
- Fast adjustment of dimensions
- Centerline of tubes and pipes adjust easily in seconds
- Steel frame coated for maintenancefree finish
- Rollers made of stainless steel
- Extension of the Pipe Feeder possible with Extension Unit
- Saves time and money
- No contamination
- Perfect for all kinds of steel

Base unit:

Fits all pipe cutting and beveling machines in the GF and RA series from Orbitalum Tools (except the RA 21 S and GF 20 AVM. RA 2, GFX 3.0, PS 4.5 and PS 6.6 on request). The machines can be directly mounted onto the base plate of the pipe feeder base unit, without further parts. The machines can be easily adjusted to the required cutting dimension using the handwheel-operated mechanical height adjustment. The machine is securely fastened to the base plate.



Pipe feeder base unit

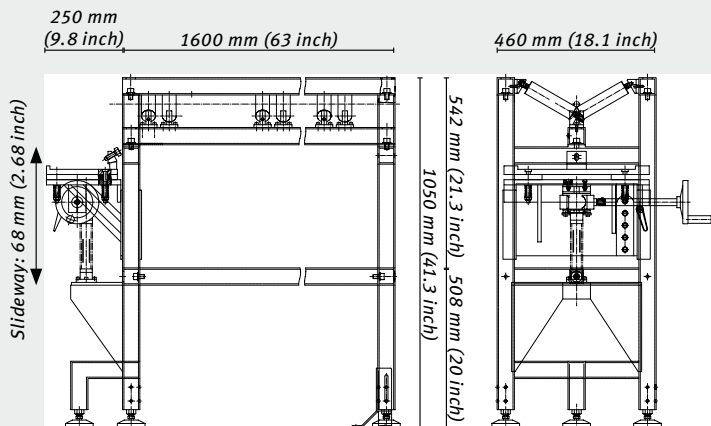

Extension unit:

To extend the the base unit, can be used singularly or in multiples, easily bolted together.



Pipe feeder extension unit

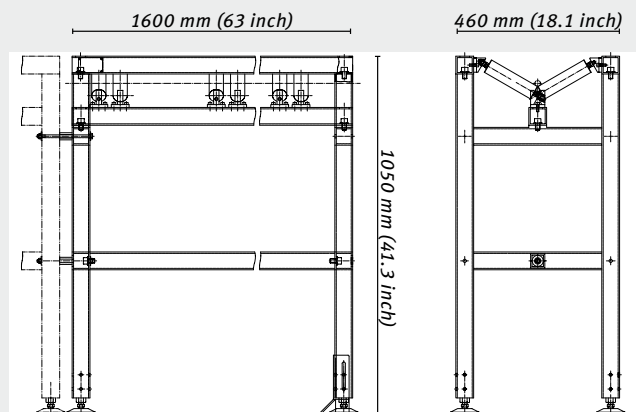

Floor bracket accessory:

To fasten the base unit or the extension unit to the floor.
The assembly consists of 4 brackets and 8 bolts with washers.

Application range/ Technical data	Pipe feeder base unit	Pipe feeder extension unit
Pipe OD	16 - 325 mm 0.63 - 12.8 inch	16 - 325 mm 0.63 - 12.8 inch
Dimensions approx.	185 x 105 x 50 cm 72.8 x 41.3 x 19.7 inch	approx. 160 x 105 x 50 62.9 x 41.3 x 19.7 inch
Load capacity max.	400 kg 881.8 lbs	400 kg 881.8 lbs
Height-adjustable mounting plate (adjusting range)	68 mm 2.68 inch	- -

Article	Code	kg
Pipe feeder base unit	790 068 051	116.000
Pipe feeder extension unit	790 068 061	72.000
Floor bracket accessory	790 068 053	1.900

Mobile Workstation

For the mobile site and/or workshop. The ideal addition for all Orbitalum pipe cutters (with exception of GF 20 AVM, RA 2, GFX 3.0, PS 4.5 and PS 6.6 on request).

- Safe and easy transportation of machines and equipment on site
- Flexible operation at each working station
- Elimination of material handling and setting up of the machines e.g. no requirement to mount the machines to benches
- Height-adjustable pipe support with stainless steel roller
- The tool box comes with 4 drawers for tools and equipment and is lockable
- Lifting table with height adjustment of the GF- and RA-machines to the required pipe dimension
- Accurate and clean work by swarf collection tray



Mobile Workstation

Technical data	Mobile Workstation
Dimensions (hxlxw)	91 x 115 x 43 cm 35.8 x 45.3 x 16.9 inch
Load capacity max.	675 kg 1488.1 lbs

Article	Code	kg
Mobile Workstation	790 068 071	137.000



For highest requirements and longest service life!



Burr-free and deformation-free



Square



Cutting and beveling

» Innovative manufacturing methods and special cutting geometry ensure a precise, square and burr-free cut «

Saw blades and bevel cutters for GF and RA machines

These saw blades and bevel cutters are especially designed for our pipe cutters for highest requirements and longest service life. 4 different ranges of saw blades are available:

- **Economy Range** for low and non-alloy steels and cast iron pipes
- **Performance Range** for high-alloy steels (stainless steel)
- **High Performance Range** for high-performance materials and high-alloy steels
- **Premium Range** especially made for stainless steel applications with extra long durability

Workable pipe materials	Al	Mild steel, Cu, CuNi, CuZn, CuSn	INOX, V2A, V4A, 304, 316 (L)	Ti, Duplex, Inconel
Economy	*	*		
Performance		*	*	
High-Performance		*	*	*
Premium			*	

Saw blades

Minimum purchase: 5 blades

Version	Pipe wall thickness		Saw blade Ø		Code	kg
	[mm]	[inch]	[mm]	[inch]		
Economy	1.2 - 2.5	.047 - .098	63	2.480	790 041 135	0.035
Economy*	1.5 - 6.0	.059 - .236	68	2.677	790 042 063	0.036
Economy	2.0 - 5.5	.079 - .217	63	2.480	790 041 020	0.032
Economy	2.5 - 7.0	.098 - .276	68	2.677	790 042 020	0.045
Economy*	5.0 - 12.0	.197 - .472	80	2.953	790 043 030	0.053
Economy*	6.0 - 15.0	.236 - .591	100	3.937	790 047 030	0.117
Performance	0.6 - 1.2	.024 - .047	63	2.480	790 041 036	0.027
Performance	1.0 - 1.6	.039 - .063	68	2.677	790 042 049	0.040
Performance	1.0 - 3.0	.039 - .118	63	2.480	790 048 072	0.025
Performance	1.2 - 2.5	.047 - .098	63	2.480	790 041 035	0.045
Performance	1.2 - 2.5	.047 - .098	68	2.677	790 042 064	0.050
Performance**	1.2 - 2.5	.047 - .098	100	3.937	790 043 036	0.104
Performance	1.2 - 3.0	.047 - .118	83	3.268	790 043 024	0.060
Performance	1.5 - 2.5	.059 - .098	80	3.150	790 046 022	0.085
Performance	2.5 - 5.5	.098 - .217	63	2.480	790 041 048	0.035
Performance**	2.5 - 5.5	.098 - .217	100	3.937	790 043 038	0.104
Performance	2.5 - 7.0	.098 - .276	68	2.677	790 042 048	0.045
Performance	2.5 - 7.0	.098 - .276	80	3.150	790 043 018	0.060
Performance	6.0 - 10.0	.236 - .394	80	2.953	790 043 022	0.055
Performance**	6.0 - 15.0	.236 - .591	100	3.937	790 047 026	0.105
High-Performance	1.2 - 2.5	.047 - .098	80	3.150	790 046 021	0.064
High-Performance	1.2 - 2.5	.047 - .098	63	2.480	790 041 034	0.031
High-Performance	2.5 - 7.0	.098 - .267	68	2.677	790 042 058	0.045
Premium	1.2 - 2.5	.047 - .098	63	2.480	790 041 049	0.033

* applicable only for aluminum pipes

** only for RA 6, RA 8, RA 12 and GF 20 AVM



Saw blade Economy



Saw blade Performance



Saw blade High-Performance



Saw blade Premium



Saw blade with additional borehole

Saw blades

Saw blades with additional borehole. Minimum purchase: 5 blades

Version	Pipe wall thickness		Saw blade Ø		Code		kg
	[mm]	[inch]	[mm]	[inch]			
Performance	1.2 - 2.5	.047 - .098	63	2.480	790 041 435		0.030
Performance	1.2 - 2.5	.047 - .098	68	2.677	790 042 464		0.037
Performance	1.5 - 2.5	.059 - .098	80	3.150	790 046 422		0.080
Performance	2.5 - 7.0	.098 - .276	68	2.677	790 042 448		0.036

Saw blade/bevel cutter combinations

Simultaneous cutting and beveling of pipes in just seconds.

Weld-prep saw blade/bevel cutter combinations (V-prep)*

Version	Pipe wall thickness		Beveling angle	Height of bevel max.		Saw blade Ø		Code		kg
	[mm]	[inch]		[mm]	[inch]	[mm]	[inch]			
Performance	1.2 - 3.0	.047 - .118	30	3	.118	63	2.480	790 044 050		0.090
Performance	2.5 - 7.0	.098 - .276	30	7	.276	68	2.677	790 042 161		0.108
High-Performance	2.5 - 5.0	.098 - .197	35	5	.197	68	2.677	790 042 015		0.120
High-Performance	2.5 - 6.0	.098 - .236	45	4	.157	68	2.677	790 042 023		0.135
High-Performance	2.5 - 7.0	.098 - .276	30	7	.276	68	2.677	790 042 013		0.108



Weld-prep saw blade/bevel cutter combinations (V-prep)

Replacement parts for weld-prep saw blade/bevel cutter combinations (V-prep)*

Article	Version	Code	kg
Saw blade for 790 044 050	Performance	790 044 040	0.027
Bevel cutter 30° for 790 044 050	Performance	790 044 049	0.065
Saw blade for 790 042 155, 790 042 157 and 790 042 161	Performance	790 042 153	0.040
Bevel cutter 30° for 790 042 161	Performance	790 042 160	0.060
Saw blade for 790 042 018, 790 042 015, 790 042 023, 790 042 013	High-Performance	790 042 016	0.040
Bevel cutter 30° for 790 042 013	High-Performance	790 042 021	0.077

Support disc for saw blade/bevel cutter combinations

We recommend the use of 1 support disc for the saw blade/bevel cutter combination.

Article	Code	kg
Support disc	790 046 188	0.068



Press fitting saw blade/bevel cutter combination

Press fitting saw blade/bevel cutter combinations**

Version	Pipe wall thickness		Beveling angle	Height of bevel max.		Saw blade Ø		Code		kg
	[mm]	[inch]		[mm]	[inch]	[mm]	[inch]			
Performance	1.0 - 2.0	.039 - .079	45 / 70	0.4/1.0	.016/.039	63	2.480	790 044 046		0.090
High-Performance	1.0 - 2.0	.039 - .079	45 / 70	0.4/1.0	.016/.039	63	2.480	790 044 047		0.090

Replacement parts for press fitting saw blade/bevel cutter combinations

Article	Version	Code	kg
Saw blade for 790 044 046	Performance	790 044 040	0.027
Saw blade for 790 044 047	High-Performance	790 044 041	0.030
Bevel cutter for 790 044 047	High-Performance	790 044 043	0.065

* Consisting of one saw blade and one bevel cutter. It is possible to order the individual parts separately.

** Consisting of one saw blade and one bevel cutter. Especially for stainless steel press fitting systems. It is possible to order the individual parts separately.

Bevel cutters

For V-prep profiles on pipe ends.

The bevel cutter is mounted on the RA pipe cutter instead of a saw blade. Reproducible weld seam preparation in just seconds.

Bevel cutters V-prep

Version	Beveling angle	Height of bevel max.		Bevel cutter Ø		Code	kg
	[°]	[mm]	[inch]	[mm]	[inch]		
Economy	30.0	9.5	.374	72	2.835	790 042 045	0.135
Economy	35.0	8.9	.350	70	2.756	790 042 037	0.170
Economy	37.5	8.4	.331	70	2.756	790 042 036	0.162
Economy	45.0	7.5	.295	70	2.756	790 042 038	0.162
Performance	30.0	9.5	.374	72	2.835	790 042 071	0.153
Performance	30.0	13.0	.512	76	2.992	790 043 023	0.187
Performance	30.0	20.0*	.787*	100	3.937	790 043 027	0.250
Performance	37.5	8.4	.331	70	2.756	790 042 070	0.163
High-Performance	30.0	9.5	.374	72	2.835	790 042 073	0.157
High-Performance	37.5	8.4	.331	70	2.756	790 042 072	0.163

* Height of bevel max. 20 mm (0.787 inch) only with aluminum pipes. Other pipe materials: max. 13 mm (0.512 inch).



Bevel cutter V-prep

Saw blade lubricant GF TOP

Synthetic high-performance lubricant for cutting and beveling machines.

Increases the tool life of the saw blade. Compliant with the food approval NSF H2.

The screwable brush guarantees an easy and uniform application of lubricant on the saw blade.

Article	Version	Code	kg
Saw blade lubricant GF TOP	Tube, 180 g	790 060 228	0.205



GF TOP

Saw blade lubricant GF LUB

The NEW chlorine-free high-performance lubricant for cutting and beveling.

Increases the tool life of the saw blade. This ecologically cutting compound is the environmentally friendly replacement for ROCOL: just with a new name and improved quality. GF LUB meets the latest environmental directives and ecological standards.

Article	Version	Code	kg
Saw blade lubricant GF LUB	Tube, 160 ml	790 041 016	0.144



GF LUB

Pipe Cutting and Beveling Technology



Tube cutting made easy!



Integrated line laser



Deformation-free clamping
of thin-walled tubes



Cutting thin-walled
stainless-steel tubes and
elbows



30

Portable Tube Saws PS

Portable Tube Saws

- Lightweight and easily transportable machine (only 23 kg (PS 4.5) or 26 kg (PS 6.6)), to provide flexibility for on-site applications
- Deformation-free clamping of thin-walled tubes
- For cutting of thin-walled tubes and elbows
- No rework necessary because of a burr-free and square cut
- Cold cutting process prevents corrosion
- Integrated line laser to identify the cut-off point
- Orbital cutting process saves time
- Multi-point clamping of the tube
- Fast adjustment of tube dimensions
- Long saw blade service life
- Press fitting saw blade combinations can be used*

PS 4.5, PS 6.6

Tube cutting made easy! Cutting thin-walled stainless-steel tubes and elbows using the superior “Planetary Cutting Technology”. Deformation-free clamping system by integrated clamping jaws made from coated cast aluminum for different tube diameters.

Machine comes with:

- 1 Portable Tube Saw PS 4.5 or PS 6.6
- 1 Set of cast aluminum clamping jaws
- 1 Durable storage and shipping case
- 1 Saw blade, already mounted on the PS-machine (Code 790 048 072)
- 1 Tool bag equipped with tools
- 1 Tube of saw blade lubricant GF TOP (Code 790 060 228)
- 1 Set of operating instructions and spare parts list



PS 4.5



PS 6.6

Application range	PS 4.5	PS 6.6
Tube OD	6 - 120 mm 0.236 - 4.724 inch	50** - 170 mm 1.969** - 6.693 inch
Elbow OD	30 - 120 mm 1.181 - 4.724 inch	50** - 170 mm 1.969** - 6.693 inch
Wall thickness max.	< 3 mm < 0.118 inch	< 3 mm < 0.118 inch
Technical data	Electric drive (single-phase AC motor)	
Dimensions	480 x 230 x 600 mm 20.9 x 9.1 x 23.6 inch	480 x 230 x 660 mm 20.9 x 9.1 x 26 inch
Power	1100 W 1.5 hp	1100 W 1.5 hp
Protection class	Protection isolated class II, DIN VDE 0740	
Speed	30 - 165 rpm	30 - 165 rpm
Vibration level (EN 28662, part 1)	< 2.5 m/s ²	< 2.5 m/s ²
Noise level at the workplace	approx. 78 dB (A)	approx. 78 dB (A)

* Only with saw blade/bevel cutter combinations of Orbitalum Tools: Code 790 044 046 or 790 044 047. Especially for stainless steel press fitting systems. Consisting of one saw blade and one bevel cutter. It is possible to order the individual parts separately. Workable wall thickness: 1 - 2 mm (0.039 - 0.079 inch), beveling angle: 45°/70°, height of bevel: max. 0.4/1 mm (0.016/0.039 inch).

** It is possible to cut tubes with a outer diameter min. 30 mm (1.181 inch) with the PS 6.6 by using additional clamping jaws (accessory, Code 790 048 380). These clamping jaws are delivered as a standard with the PS 4.5.

Article	Version	Code	Weight of machine kg	Dispatch weight kg
PS 4.5	230 V, 50/60 Hz EU	790 048 001	23.600	37.000
PS 4.5	110 V, 50/60 Hz EU	790 048 002	23.600	37.000
PS 4.5	120 V, 50/60 Hz US	790 048 003	23.600	37.000
PS 6.6	230 V, 50/60 Hz EU	790 049 001	26.300	41.000
PS 6.6	110 V, 50/60 Hz EU	790 049 002	26.300	41.000
PS 6.6	120 V, 50/60 Hz US	790 049 003	26.300	41.000

Pipe Cutting and Beveling Technology

31

Accessories for PS machines



Quick-mounting plate with screw clamps



Saw blade Performance



Tripod



Clamping jaws replacement set



Laser retrofitting kit

Quick-mounting plate with screw clamps

Quick and easy mounting of the machine to the bench with no drilling.
Including 4 socket head screws to fix the PS to the quick-mounting base plate.

Article	Code	kg
Quick-mounting plate with screw clamps	790 048 334	2.600

Saw blades

Performance range for high-alloy steels (stainless steel).
Recommended saw blades for the Portable Tube Saws PS 4.5 and PS 6.6.

Version	Tube wall thickness [mm]	Tube wall thickness [inch]	Saw blade Ø [mm]	Saw blade Ø [inch]	Code	kg
Performance	1.0 - 3.0	0.039 - 0.118	63	2.480	790 048 072	0.035
Performance	0.6 - 1.2	0.024 - 0.047	63	2.480	790 041 036	0.027

Tripod

Made of stainless steel.
For easy mounting of PS machines directly on the tripod with no base plate.
Space saving – fast application – easy handling.

Article	Code	kg
Tripod	790 048 335	10.600

Clamping jaws replacement set

Made from coated cast aluminum. Extends the dimension range of the PS 6.6 to OD min. 30 mm (1.181 inch).

Article	Code	kg
Clamping jaws replacement set for PS 4.5 and extension jaws for PS 6.6	790 048 380	2.030

Laser retrofitting kit

Line laser to identify the cutting point on the tube.
Easy mounting on the swivel on the PS machines. Kit contains 1 line laser, 1 laser holder with 2 fixing screws, replacement batteries, 1 set of assembly instructions.

Article	Code	kg
Laser retrofitting kit for PS 4.5 and PS 6.6	790 048 060	0.150



Ideal for to use on construction sites and in industrial pipe installations!



Powerful and lightweight machine



Including TCT saw blade for steel, copper, aluminum and plastic pipes. DIAMOND blade for cast iron pipes and CERMET blade for stainless steel pipes available



Including pipe rollers



Universal Pipe Cutter SCORP



SCORP 220 Plus



SCORP 360



Pipe roller (small)



Bag for easy transportation

Universal Pipe Cutter

- Powerful and lightweight machine
- Secure operation by means of overload protection and chip guard
- Burr-free and square cut
- Corrosion and heat resistant
- Wide range of applications and dimensions
- No rework necessary
- The cut is square enough for a mechanical clamping joint
- Reduction of tool costs and cutting time

SCORP 220 Plus, SCORP 360

The new way of cutting cast iron, stainless steel, steel, copper, aluminum and plastic pipes. Ideal for pipe fitters to use on construction sites and in industrial pipe installations.

Machine comes with:

- 1 Universal Pipe Cutter SCORP
- 1 Bag for easy transportation
- Pipe rollers:
SCORP 220 Plus: 4 small pipe rollers (Code 790 014 028)
SCORP 360: 2 small (Code 790 014 029) and 1 large pipe roller (Code 790 015 030)
- 1 Saw blade TCT (Code 790 014 055)
- 1 Set of operating instructions and spare parts list

Application range	SCORP 220 Plus	SCORP 360
Pipe OD	20 - 220 mm 0.800 - 8.660 inch	75 - 360 mm 2.950 - 14.170 inch
Wall thickness (steel) max.	8 mm 0.315 inch	8 mm 0.315 inch
Wall thickness (plastic) max.	10 mm 0.394 inch	27.9 mm* 1.098 inch*
Technical data	Electric drive with single-phase AC motor	
Dimensions	35 x 22 x 28 cm 13.8 x 8.7 x 11.0 inch	50 x 22 x 30 cm 19.7 x 8.7 x 11.8 inch
Power	1,100 W / 1.5 hp	1,400 W / 1.9 hp
Intermittent operation	S3 10 min. 25%	S3 10 min. 25%
Saw blade Ø	140 mm / 5.512 inch	140 mm / 5.512 inch 155 mm / 6.102 inch
Saw blade shaft Ø	62 mm / 2.441 inch	62 mm / 2.441 inch
Saw blade thickness max.	1.5 - 2 mm 0.059 - 0.079 inch	1.5 - 2 mm 0.059 - 0.079 inch
Max. cutting width saw blade	2.0 mm / 0.079 inch	2.0 mm / 0.079 inch
Rotation speed	4,000 rpm	4,000 rpm
Noise level at the workplace according to EN 60745, approx.	95.5 dB (A)	95.5 dB (A)
Vibration level according to EN 60745	< 2.5 m/s ²	< 2.5 m/s ²

* depends on dimension

Article	Version	Code	Weight of machine kg	Dispatch weight kg
SCORP 220 Plus	230 V, 50/60 Hz	790 014 007	8.700	15.000
SCORP 360	230 V, 50/60 Hz	790 015 001	14.800	24.400

Saw blades for SCORP machines

Saw blade TCT

Article	For pipe materials	Saw blade Ø [mm/inch]	rpm max.	Code	kg
Saw blade TCT	Steel, copper, aluminum, all kinds of plastic	140/5.512	4,200	790 014 055	0.154

Application range SCORP 360 with TCT saw blade

Plastic pipe OD		Saw blade Ø 140 mm/5.512 inch max. wall thickness	
[mm]	[inch]	[mm]	[inch]
75	2.953	15.1	0.594
90	3.543	11.4	0.449
100	3.937	10.1	0.398
110	4.331	9.3	0.366
115	4.528	9.1	0.358
125	4.921	8.8	0.346
140	5.512	8.7	0.343
160	6.299	9.1	0.358
165	6.496	9.3	0.366
180	7.087	9.9	0.390
190	7.480	10.4	0.409
200	7.874	10.9	0.429
215	8.465	11.8	0.465
225	8.858	12.4	0.488
240	9.449	13.4	0.528
250	9.843	14.0	0.551
270	10.630	15.4	0.606
280	11.024	16.0	0.630
315	12.402	18.3	0.720
320	12.598	18.6	0.732
355	13.976	20.4	0.803



Saw blade TCT

Cutting blade Diamond

Article	For pipe materials	Cutting blade Ø [mm/inch]	rpm max.	Code	kg
Cutting blade Diamond	Cast iron	140/5.512	4,200	790 014 057	0.173
Cutting blade Diamond*	Cast iron	155/6.102	4,200	790 014 059	0.200

* only for SCORP 360



Cutting blade Diamond

Saw blade Cermet

Article	For pipe materials	Saw blade Ø [mm/inch]	rpm max.	Code	kg
Saw blade Cermet	Stainless steel	140/5.512	4,200	790 014 056	0.153



Saw blade Cermet



Manual cutting of metal tubes in any position!



Guiding of the multi-roller cutting chain and the MRA through the clamping shells

Diameter-specific clamping shells

Durable storage and shipping case

Multi-roller cutting chains: The cutting wheels are made from hardened steel

36

Metal Tube Cutter MRA

Metal Tube Cutter

The clever solution for cutting metal tubes manually. This Metal Tube Cutter is especially designed for cramped working places and for chipless cutting processes.

- Deformation-free and square cut
- No electricity required
- Requires little space, for use in limited access areas

MRA

For manual cutting of metal tubes in any position.
Easy to use – first-rate cutting technology.

The patented cutting technique used in designing the MRA is based on the diameter-specific clamping shells and the flexible multi-roller cutting chain. Both these components are made of hardened, wear resistant steel and provide the following advantages:

- Long service life of the components
- The cutting chain is at a right-angle around the tube
- The MRA runs on track rollers on the clamping shells
- Minimum hand movements
- Tubes made of stainless steel can be cut

For tube materials:

- High-alloy steel (stainless steel material e.g. no. 1.40... to 1.45... or 304/316 materials)
- Low-alloy and unalloyed steel
- Cast materials
- Non-ferrous metals

Comes with:

- 1 Metal Tube Cutter MRA*
- 1 Durable storage and shipping case
- 1 Socket head key
- 1 Connection clamp
- 1 Pair of working gloves
- 1 Set of operating instructions and spare parts list

* without multi-roller cutting chains and without clamping shells (see accessories)



MRA

Application range	MRA
Tube OD	33.7 - 254.0 mm 1.327 - 10.000 inch
Wall thickness (depends on material)*	0.8 - 3.0 mm 0.031 - 0.118 inch
Technical data	
Dimensions	450 x 105 mm 17.7 x 4.1 inch

* for high-alloy steels, the max. wall thickness which can be processed is 2.0 - 2.5 mm (0.08 - 0.09 inch).

Article	Code	Weight of machine kg	Dispatch weight kg
Metal Tube Cutter MRA	790 008 001	3.100	8.000

Accessories for MRA

Multi-roller cutting chains

Cutting wheels made from hardened steel.



Multi-roller cutting chain

Article	Tube OD [mm]	Tube OD [inch]	Number of cutting wheels [pieces]	Code	kg
Multi-roller cutting chain for MRA	33.7 - 114.3	1.330 - 4.500	15	790 008 018	0.500
Multi-roller cutting chain for MRA	114.3 - 254.0	4.500 - 10.000	16	790 008 041	0.900

Clamping shells

Set of two pieces, made from hardened steel. One pair of clamping shells needed for each tube size. Further dimensions of clamping shells are available on request.



Clamping shells

Article	Tube OD [mm]	Tube OD [inch]	Code	kg
Clamping shells for MRA	25.0	0.984	790 008 102	0.750
Clamping shells for MRA	25.4	1.000	790 008 104	0.795
Clamping shells for MRA	29.0	1.142	790 008 103	0.835
Clamping shells for MRA	33.7	1.330	790 008 105	0.885
Clamping shells for MRA	38.1	1.500	790 008 130	0.955
Clamping shells for MRA	40.0	1.575	790 008 135	0.955
Clamping shells for MRA	42.4	1.670	790 008 140	1.005
Clamping shells for MRA	44.5	1.752	790 008 150	1.052
Clamping shells for MRA	48.3	1.900	790 008 155	1.100
Clamping shells for MRA	50.0	1.970	790 008 160	1.130
Clamping shells for MRA	50.8	2.000	790 008 165	1.140
Clamping shells for MRA	52.0	2.050	790 008 175	1.190
Clamping shells for MRA	53.0	2.087	790 008 180	1.150
Clamping shells for MRA	54.0	2.125	790 008 185	1.100
Clamping shells for MRA	57.0	2.244	790 008 190	1.200
Clamping shells for MRA	60.3	2.375	790 008 195	1.315
Clamping shells for MRA	63.5	2.500	790 008 200	1.375
Clamping shells for MRA	65.0	2.559	790 008 203	1.375
Clamping shells for MRA	70.0	2.755	790 008 215	1.445
Clamping shells for MRA	73.0	2.874	790 008 220	1.480
Clamping shells for MRA	75.0	2.950	790 008 225	1.600
Clamping shells for MRA	76.1	2.996	790 008 230	1.560
Clamping shells for MRA	80.0	3.150	790 008 233	1.375
Clamping shells for MRA	84.0	3.300	790 008 240	1.690
Clamping shells for MRA	85.0	3.350	790 008 245	1.750
Clamping shells for MRA	88.9	3.500	790 008 250	1.780
Clamping shells for MRA	100.0	3.937	790 008 255	1.970
Clamping shells for MRA	101.6	4.000	790 008 260	2.025
Clamping shells for MRA	104.0	4.095	790 008 270	1.925
Clamping shells for MRA	108.0	4.252	790 008 280	2.100
Clamping shells for MRA	110.0	4.330	790 008 285	2.150
Clamping shells for MRA	114.3	4.500	790 008 290	2.295
Clamping shells for MRA	129.0	5.080	790 008 315	3.000
Clamping shells for MRA	139.7	5.500	790 008 325	3.365
Clamping shells for MRA	150.0	5.906	790 008 333	3.375
Clamping shells for MRA	152.4	6.000	790 008 335	3.232
Clamping shells for MRA	154.0	6.060	790 008 340	3.365
Clamping shells for MRA	160.0	6.300	790 008 355	3.520
Clamping shells for MRA	165.0	6.496	790 008 360	4.125
Clamping shells for MRA	168.3	6.625	790 008 365	3.600
Clamping shells for MRA	204.0	8.030	790 008 380	4.375
Clamping shells for MRA	219.1	8.625	790 008 385	4.680
Clamping shells for MRA	228.6	9.000	790 008 387	4.890
Clamping shells for MRA	254.0	10.000	790 008 390	5.420



The required, high-quality tube end preparation for orbital welding!



Burr-free and square



Exact results due to micrometer/inch feed



Speed regulated electric motor



Environmentally friendly cordless versions thanks to lithium-ion technology and AIR-COOLED technology for short charging times and long service life

Tube Squaring Machines RPG ONE, 1.5, 2.5 (Cordless)

39



RPG ONE



RPG ONE Cordless



RPG 1.5



RPG 1.5 Cordless



RPG 2.5



RPG 2.5 Cordless

Tube Squaring Machines

- Squaring tube ends with a high-quality finish
- Burr-free and square
- Beveling possible with a special tool holder
- Quick clamping system for tools, clamping shells and tubes
- Preparation of thin-walled stainless steel tubes (V4A) and micro fittings
- High-performance coated tool bit with two cutting edges
- Built-in electronic speed regulation
- Micrometer feed for optimum results
- No additional tools required for operation
- Space saving, light weight and portable machine for a mobile and secure application
- Modular design, ensuring compatibility within the RPG series
- The special adaptor clamping shell allows the RPG 2.5 to be used with the clamping shells for the RPG 1.5 machines
- Machines have a removable bench stand (mains versions only)
- Machine with rotating/removable drive
- Very short design (cordless versions)

Improved features in the cordless versions thanks to lithium-ion technology:

- Motor with high performance and small size
- No memory effect
- Single cell monitoring in the cordless pack
- Electronic overload protection with integrated temperature monitor
- Robust cordless packs with capacity display
- Minimal self-discharge
- Environmentally friendly
- AIR-COOLED technology for short charging times and a long service life

RPG ONE (cordless), RPG 1.5 (cordless), RPG 2.5 (cordless)

Designed for burr-free squaring and beveling of thin-walled stainless steel tubes and micro fittings. For the required, high quality tube end preparation for orbital welding!

Machine comes with:

- 1 Tube Squaring Machine RPG ONE, RPG 1.5 or RPG 2.5 (cordless)
- 1 Durable storage and shipping case
- 2 Rechargeable batteries, 1 battery charger (for cordless versions only)
- 1 Tool holder (Code 790 037 152)
- 1 Multifunctional tool (Code 790 038 314)
- 1 Adapter clamping shell (Code 790 030 094, only for RPG 2.5)
- 1 Tool set
- 1 Set of operating instructions and spare parts list

Bench stand for cordless machines optional available (Code 790 037 169).

Application range	RPG ONE	RPG ONE cordless	RPG 1.5	RPG 1.5 cordless	RPG 2.5	RPG 2.5 cordless
Tube OD min.-max.	3.0 - 25.4 mm 0.118 - 1.0 inch	3.0 - 25.4 mm 0.118 - 1.0 inch	3.0 - 38.1 mm 0.118 - 1.5 inch	3.0 - 38.1 mm 0.118 - 1.5 inch	6.35* - 63.5 mm 0.25* - 2.5 inch	6.35* - 63.5 mm 0.25* - 2.5 inch
Wall thickness max.	3.0 mm 0.118 inch	3.0 mm 0.118 inch	3.0 mm 0.118 inch	3.0 mm 0.118 inch	3.0 mm 0.118 inch	3.0 mm 0.118 inch
Tube materials	High-alloy steels (stainless steel material no. 1.40... to 1.45... as per DIN 17 455 and DIN 17 456), unalloyed and low-alloy steels, aluminum.					
Technical data						
Dimensions (lxhxd)	390 x 200 x 70 15.4 x 7.9 x 2.8	261 x 255 x 80 10.3 x 10 x 3.2	400 x 350 x 160 15.8 x 13.8 x 6.3	275 x 255 x 90 10.8 x 10 x 3.5	500 x 300 x 170 19.7 x 11.8 x 6.7	260 x 300 x 320 10.2 x 11.8 x 12.6

Built-in electronic variable cutting speed	145 - 380 rpm	0 - 400 rpm	145 - 380 rpm	0 - 400 rpm	1. speed: 9 - 2 rpm 2. speed: 27 - 153 rpm	1. speed: 0 - 24 rpm 2. speed: 0 - 83 rpm
Power	1100 W	–	1100 W	–	1100 W	–
Voltage of rechargeable battery	–	18 V	–	18 V	–	18 V
Capacity	–	2.6 Ah	–	2.6 Ah	–	2.6 Ah

* only with special adapter clamping shell (supplied as standard with RPG 2.5)

Article	Version	Code	Weight of machine kg	Dispatch weight kg
RPG ONE	230 V, 50/60 Hz EU	790 036 031	4.140	9.600
RPG ONE	120 V, 50/60 Hz US	790 036 032	4.140	9.600
RPG ONE	110 V, 50/60 Hz EU	790 036 033	4.140	9.600
RPG ONE Cordless (18 V)	230 V, 50/60 Hz EU	790 036 021	2.880	8.200
RPG ONE Cordless (18 V)	115 V, 60 Hz US	790 036 022	2.880	8.200
RPG 1.5	230 V, 50/60 Hz EU	790 037 001	3.880	9.500
RPG 1.5	120 V, 50/60 Hz US	790 037 002	3.880	9.500
RPG 1.5	110 V, 50/60 Hz EU	790 037 003	3.880	9.500
RPG 1.5 Cordless (18 V)	230 V, 50/60 Hz EU	790 037 011	3.440	10.100
RPG 1.5 Cordless (18 V)	115 V, 60 Hz US	790 037 012	3.440	10.100
RPG 2.5	230 V, 50/60 Hz EU	790 030 001	6.600	12.500
RPG 2.5	120 V, 50/60 Hz US	790 030 002	6.600	12.500
RPG 2.5	110 V, 50/60 Hz EU	790 030 003	6.600	12.500
RPG 2.5 Cordless (18 V)	230 V, 50/60 Hz EU	790 030 011	5.340	11.320
RPG 2.5 Cordless (18 V)	110 V, 60 Hz US	790 030 012	5.340	11.320

Angle drive RPG ONE (cordless) and RPG 1.5 (cordless)

The angle drive is optionally available and may be retrofitted to the RPG ONE and RPG 1.5 (cordless). The squaring machine reduces the design length to 200 mm (7.874 inch). Technical characteristics remain unchanged.

Article	Code	kg
Angle drive for RPG ONE and RPG 1.5 (cordless)	790 037 400	0.475



Angle drive

Accessories for RPG ONE, RPG 1.5, RPG 2.5 (cordless)

Please check the outer diameter of the tubes before ordering the clamping shells.

One-piece stainless steel clamping shells

Extremely durable. Assures accurate centering and quick clamping shell change without any tools with its unique design and positive clamping shell mechanism. Further dimensions of clamping shells are available.

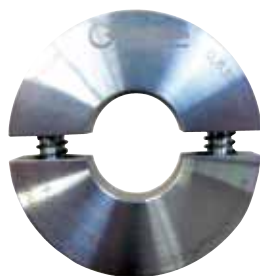

One-piece stainless steel clamping shell



One-piece stainless steel clamping shell for micro fittings

Applicable with	Applicable for	Tube OD		Tube clamping length		Code	kg
		[mm]	[inch]	[mm]	[inch]		
RPG ONE	Tubes	3.00	0.118	10.00	0.394	790 036 232	0.118
RPG ONE	Tubes	3.18	0.125	10.00	0.394	790 036 201	0.119
RPG ONE	Tubes	6.00	0.236	10.00	0.394	790 036 213	0.117
RPG ONE	Tubes	6.35	0.250	10.00	0.394	790 036 202	0.118
RPG ONE	Tubes	7.00	0.276	10.00	0.394	790 036 214	0.118
RPG ONE	Tubes	8.00	0.315	10.00	0.394	790 036 215	0.116
RPG ONE	Tubes	9.53	0.375	10.00	0.394	790 036 203	0.115
RPG ONE	Tubes	10.00	0.394	10.00	0.394	790 036 204	0.115
RPG ONE	Tubes	10.10	0.398	10.00	0.394	790 036 222	0.114
RPG ONE	Tubes	11.00	0.433	10.00	0.394	790 036 226	0.112
RPG ONE	Tubes	12.00	0.472	10.00	0.394	790 036 205	0.112
RPG ONE	Tubes	12.10	0.476	10.00	0.394	790 036 223	0.111
RPG ONE	Tubes	12.70	0.500	10.00	0.394	790 036 206	0.111
RPG ONE	Tubes	13.50	0.531	10.00	0.394	790 036 227	0.110
RPG ONE	Tubes	14.00	0.551	10.00	0.394	790 036 228	0.108
RPG ONE	Tubes	14.10	0.555	10.00	0.394	790 036 224	0.107
RPG ONE	Tubes	15.00	0.590	10.00	0.394	790 036 216	0.107
RPG ONE	Tubes	15.60	0.614	10.00	0.394	790 036 225	0.105
RPG ONE	Tubes	15.88	0.625	10.00	0.394	790 036 211	0.105
RPG ONE	Tubes	16.00	0.630	10.00	0.394	790 036 212	0.104
RPG ONE	Tubes	17.00	0.670	10.00	0.394	790 036 221	0.103
RPG ONE	Tubes	17.20	0.677	10.00	0.394	790 036 207	0.104
RPG ONE	Tubes	18.00	0.709	10.00	0.394	790 036 217	0.102
RPG ONE	Tubes	19.05	0.750	10.00	0.394	790 036 208	0.100
RPG ONE	Tubes	20.00	0.787	10.00	0.394	790 036 230	0.096
RPG ONE	Tubes	21.30	0.839	10.00	0.394	790 036 209	0.094
RPG ONE	Tubes	21.70	0.854	10.00	0.394	790 036 220	0.093
RPG ONE	Tubes	22.00	0.866	10.00	0.394	790 036 218	0.093
RPG ONE	Tubes	23.00	0.906	10.00	0.394	790 036 219	0.085
RPG ONE	Tubes	25.00	0.984	10.00	0.394	790 036 231	0.081
RPG ONE	Tubes	25.40	1.000	10.00	0.394	790 036 210	0.083
RPG ONE	Micro fittings	6.00	0.236	4.00	0.157	790 036 304	0.066
RPG ONE	Micro fittings	6.35	0.250	4.00	0.157	790 036 301	0.066
RPG ONE	Micro fittings	8.00	0.315	4.00	0.157	790 036 307	0.065
RPG ONE	Micro fittings	9.53	0.375	4.00	0.157	790 036 302	0.064
RPG ONE	Micro fittings	10.00	0.394	4.00	0.157	790 036 305	0.065
RPG ONE	Micro fittings	12.00	0.472	4.00	0.157	790 036 306	0.064
RPG ONE	Micro fittings	12.70	0.500	4.00	0.157	790 036 303	0.062
RPG 1.5	Tubes	3.00	0.118	15.00	0.591	790 037 220	0.300
RPG 1.5	Tubes	3.18	0.125	15.00	0.591	790 037 221	0.308
RPG 1.5	Tubes	4.00	0.157	15.00	0.591	790 037 222	0.308
RPG 1.5	Tubes	4.78	0.188	15.00	0.591	790 037 223	0.308
RPG 1.5	Tubes	5.00	0.197	15.00	0.591	790 037 224	0.290
RPG 1.5	Tubes	6.00	0.236	15.00	0.591	790 037 225	0.310
RPG 1.5, RPG 2.5	Tubes	6.35	0.250	15.00	0.591	790 037 226	0.306
RPG 1.5, RPG 2.5	Tubes	7.00	0.276	15.00	0.591	790 037 257	0.306
RPG 1.5, RPG 2.5	Tubes	8.00	0.314	15.00	0.591	790 037 227	0.299
RPG 1.5, RPG 2.5	Tubes	9.00	0.354	15.00	0.591	790 037 254	0.280
RPG 1.5, RPG 2.5	Tubes	9.53	0.375	15.00	0.591	790 037 228	0.297
RPG 1.5, RPG 2.5	Tubes	10.00	0.394	15.00	0.591	790 037 229	0.298
RPG 1.5, RPG 2.5	Tubes	11.00	0.433	15.00	0.591	790 037 293	0.252
RPG 1.5, RPG 2.5	Tubes	11.11	0.437	15.00	0.591	790 037 255	0.295
RPG 1.5, RPG 2.5	Tubes	12.00	0.472	15.00	0.591	790 037 230	0.293

Applicable with	Applicable for	Tube OD		Tube clamping length		Code	kg
		[mm]	[inch]	[mm]	[inch]		
RPG 1.5, RPG 2.5	Tubes	12.70	0.500	15.00	0.591	790 037 231	0.292
RPG 1.5, RPG 2.5	Tubes	13.00	0.512	15.00	0.591	790 037 232	0.291
RPG 1.5, RPG 2.5	Tubes	13.20	0.520	15.00	0.591	790 037 263	0.290
RPG 1.5, RPG 2.5	Tubes	13.50	0.531	15.00	0.591	790 037 233	0.290
RPG 1.5, RPG 2.5	Tubes	14.00	0.551	15.00	0.591	790 037 234	0.288
RPG 1.5, RPG 2.5	Tubes	14.30	0.563	15.00	0.591	790 037 253	0.289
RPG 1.5, RPG 2.5	Tubes	14.70	0.579	15.00	0.591	790 037 290	0.287
RPG 1.5, RPG 2.5	Tubes	15.00	0.591	15.00	0.591	790 037 235	0.286
RPG 1.5, RPG 2.5	Tubes	15.30	0.602	15.00	0.591	790 037 259	0.287
RPG 1.5, RPG 2.5	Tubes	15.70	0.618	15.00	0.591	790 037 291	0.284
RPG 1.5, RPG 2.5	Tubes	15.88	0.625	15.00	0.591	790 037 236	0.285
RPG 1.5, RPG 2.5	Tubes	16.00	0.630	15.00	0.591	790 037 237	0.282
RPG 1.5, RPG 2.5	Tubes	17.00	0.669	15.00	0.591	790 037 256	0.280
RPG 1.5, RPG 2.5	Tubes	17.08	0.672	15.00	0.591	790 037 260	0.281
RPG 1.5, RPG 2.5	Tubes	17.20	0.677	15.00	0.591	790 037 238	0.300
RPG 1.5, RPG 2.5	Tubes	18.00	0.709	15.00	0.591	790 037 239	0.280
RPG 1.5, RPG 2.5	Tubes	19.00	0.748	15.00	0.591	790 037 240	0.277
RPG 1.5, RPG 2.5	Tubes	19.05	0.750	15.00	0.591	790 037 241	0.274
RPG 1.5, RPG 2.5	Tubes	20.00	0.787	15.00	0.591	790 037 242	0.272
RPG 1.5, RPG 2.5	Tubes	21.00	0.827	15.00	0.591	790 037 294	0.270
RPG 1.5, RPG 2.5	Tubes	21.30	0.839	15.00	0.591	790 037 243	0.270
RPG 1.5, RPG 2.5	Tubes	21.70	0.854	15.00	0.591	790 037 261	0.270
RPG 1.5, RPG 2.5	Tubes	22.00	0.866	15.00	0.591	790 037 244	0.264
RPG 1.5, RPG 2.5	Tubes	22.22	0.875	15.00	0.591	790 037 292	0.270
RPG 1.5, RPG 2.5	Tubes	23.00	0.906	15.00	0.591	790 037 245	0.261
RPG 1.5, RPG 2.5	Tubes	24.00	0.945	15.00	0.591	790 037 246	0.256
RPG 1.5, RPG 2.5	Tubes	25.00	0.984	15.00	0.591	790 037 247	0.252
RPG 1.5, RPG 2.5	Tubes	25.40	1.000	15.00	0.591	790 037 248	0.240
RPG 1.5, RPG 2.5	Tubes	26.90	1.059	15.00	0.591	790 037 249	0.260
RPG 1.5, RPG 2.5	Tubes	27.00	1.063	15.00	0.591	790 037 264	0.260
RPG 1.5, RPG 2.5	Tubes	27.20	1.071	15.00	0.591	790 037 262	0.260
RPG 1.5, RPG 2.5	Tubes	28.00	1.102	15.00	0.591	790 037 250	0.238
RPG 1.5, RPG 2.5	Tubes	29.00	1.142	15.00	0.591	790 037 251	0.235
RPG 1.5, RPG 2.5	Tubes	30.00	1.181	15.00	0.591	790 037 252	0.232
RPG 1.5, RPG 2.5	Tubes	31.80	1.250	15.00	0.591	790 037 280	0.230
RPG 1.5, RPG 2.5	Tubes	32.00	1.260	15.00	0.591	790 037 258	0.226
RPG 1.5, RPG 2.5	Tubes	33.40	1.315	15.00	0.591	790 037 281	0.220
RPG 1.5, RPG 2.5	Tubes	33.70	1.327	15.00	0.591	790 037 282	0.218
RPG 1.5, RPG 2.5	Tubes	34.00	1.339	15.00	0.591	790 037 283	0.210
RPG 1.5, RPG 2.5	Tubes	35.00	1.377	15.00	0.591	790 037 284	0.210
RPG 1.5, RPG 2.5	Tubes	36.00	1.417	15.00	0.591	790 037 285	0.204
RPG 1.5, RPG 2.5	Tubes	38.00	1.496	15.00	0.591	790 037 286	0.199
RPG 1.5, RPG 2.5	Tubes	38.10	1.500	15.00	0.591	790 037 287	0.194
RPG 2.5	Tubes	40.00	1.575	15.00	0.591	790 030 234	0.565
RPG 2.5	Tubes	41.00	1.614	15.00	0.591	790 030 230	0.560
RPG 2.5	Tubes	42.00	1.654	15.00	0.591	790 030 117	0.500
RPG 2.5	Tubes	42.40	1.669	15.00	0.591	790 030 227	0.483
RPG 2.5	Tubes	42.70	1.681	15.00	0.591	790 030 224	0.483
RPG 2.5	Tubes	43.00	1.693	15.00	0.591	790 030 231	0.544
RPG 2.5	Tubes	44.50	1.752	15.00	0.591	790 030 228	0.483
RPG 2.5	Tubes	48.30	1.902	15.00	0.591	790 030 226	4.990
RPG 2.5	Tubes	50.80	2.000	15.00	0.591	790 030 220	0.483
RPG 2.5	Tubes	51.00	2.008	15.00	0.591	790 030 233	0.482
RPG 2.5	Tubes	52.00	2.047	15.00	0.591	790 030 225	0.483
RPG 2.5	Tubes	53.00	2.087	15.00	0.591	790 030 232	0.457
RPG 2.5	Tubes	54.00	2.126	15.00	0.591	790 030 221	0.452
RPG 2.5	Tubes	55.00	2.165	15.00	0.591	790 030 235	0.440
RPG 2.5	Tubes	57.00	2.244	15.00	0.591	790 030 229	0.419
RPG 2.5	Tubes	60.30	2.374	15.00	0.591	790 030 222	0.386
RPG 2.5	Tubes	63.50	2.500	15.00	0.591	790 030 223	0.350
RPG 2.5	Tubes	65.00	2.559	15.00	0.591	790 030 236	0.330
RPG 1.5	Micro fittings	3.00	0.118	4.00	0.157	790 037 300	0.241
RPG 1.5	Micro fittings	3.18	0.125	4.00	0.157	790 037 301	0.227
RPG 1.5	Micro fittings	4.00	0.157	4.00	0.157	790 037 302	0.237
RPG 1.5	Micro fittings	4.78	0.188	4.00	0.157	790 037 303	0.234
RPG 1.5	Micro fittings	5.00	0.197	4.00	0.157	790 037 304	0.228
RPG 1.5	Micro fittings	6.00	0.236	4.00	0.157	790 037 305	0.220
RPG 1.5, RPG 2.5	Micro fittings	6.35	0.250	4.00	0.157	790 037 306	0.460
RPG 1.5, RPG 2.5	Micro fittings	8.00	0.314	4.00	0.157	790 037 307	0.223

Applicable with	Applicable for	Tube OD		Tube clamping length		Code	kg
		[mm]	[inch]	[mm]	[inch]		
RPG 1.5, RPG 2.5	Micro fittings	9.53	0.375	4.00	0.157	790 037 308	0.300
RPG 1.5, RPG 2.5	Micro fittings	10.00	0.394	4.00	0.157	790 037 309	0.222
RPG 1.5, RPG 2.5	Micro fittings	12.00	0.472	4.00	0.157	790 037 310	0.220
RPG 1.5, RPG 2.5	Micro fittings	12.50	0.492	4.00	0.157	790 037 317	0.220
RPG 1.5, RPG 2.5	Micro fittings	12.70	0.500	4.00	0.157	790 037 311	0.220
RPG 1.5, RPG 2.5	Micro fittings	17.20	0.678	4.00	0.157	790 037 312	0.220
RPG 1.5, RPG 2.5	Micro fittings	19.00	0.748	4.00	0.157	790 037 314	0.216
RPG 1.5, RPG 2.5	Micro fittings	19.05	0.750	4.00	0.157	790 037 315	0.215
RPG 1.5, RPG 2.5	Micro fittings	21.20	0.835	4.00	0.157	790 037 313	0.213
RPG 1.5, RPG 2.5	Micro fittings	21.30	0.839	4.00	0.157	790 037 318	0.212



Adapter clamping shell

Adapter clamping shell for RPG 2.5

Using this adapter clamping shell, the clamping shells for the RPG 1.5 can also be used for the RPG 2.5 machines, extending the range of application to min. 6.35 mm (0.250 inch).
Supplied as standard with the RPG 2.5.

Article	Code	kg
Adapter clamping shell for RPG 2.5	790 030 094	0.150

Tool holder WH

Fits multifunctional tool **790 038 314**. incl. Torx fixing screw.
For max. wall thickness 3 mm (0.118 inch).



Tool holder WH

Application range	Possible application		Beveling angle	Tube OD					
	Squaring	Beveling		RPG ONE (cordless)		RPG 1.5 (cordless)		RPG 2.5 (cordless)	
			[°]	[mm]	[inch]	[mm]	[inch]	[mm]	[inch]
WH12-I**	x	-	-	3.0 - 25.4	0.118 - 1.0	3.0 - 38.1	0.118 - 1.5	6.35 - 63.5	0.25 - 2.5
WH12-I (optional)	x	-	-	12.7 - 25.4	0.5 - 1.0	12.7 - 38.1	0.5 - 1.5	12.7 - 63.5	0.5 - 2.5
WH12-I (micro fittings)*	x	-	-	-	-	3.0 - 21.3	0.118 - 0.84	6.35 - 21.3	0.25 - 0.84
WH3-V-30	-	x	30°	-	-	max. 35.0	max. 1.378	max. 60.3	max. 2.374
WH3-V-35	-	x	35°	-	-	max. 34.0	max. 1.339	max. 59.3	max. 2.335
WH3-V-45	-	x	45°	-	-	max. 33.7	max. 1.327	max. 59.0	max. 2.323

Article	Code	kg
Standard tool holder WH12-I	790 037 152	0.040
Optional tool holder WH12-I	790 037 154	0.050
Optional tool holder for micro fittings WH12-I*	790 037 156	0.100
Tool holder WH3-V-30	790 037 158	0.024
Tool holder WH3-V-35	790 037 159	0.024
Tool holder WH3-V-45	790 037 157	0.022

* Only to be used with stainless steel clamping shells for micro fittings.

** Recommended application range with the standard tool holder: 3.0 - 12.7 mm (0.118 - 0.5 inch).

Multifunctional tool MFW

Two-sided tool bit with high-performance Balinit® Futura protective coating against tool wear. Usable for all machines of the RPG series.

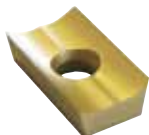

Multifunctional tool MFW

Article	Quantity	Code	kg
Multifunctional tool MFW-P-2	1	790 038 314	0.003
Multifunctional tool MFW-P-2	10	790 038 315	0.045



The clean and high-value solution for specific welding preparations!



QTC® Quick-Tool-Change:
Quick clamping system for
tools, clamping shells and
tubes



A wide range of stainless steel
clamping shells (for RPG 8.6
also made from aluminum)



Including durable storage
and shipping case:
High-quality blue transportation
case with insert
Very sturdy design.



Including tool holder WH
and high-performance coated
tool bit MFW with two
cutting edges

Tube Squaring Machines RPG 4.5, RPG 8.6

45

Tube Squaring Machines

- Squaring tube ends with a high-quality finish
- Burr-free and square
- Beveling possible with a special tool holder
- Quick clamping system for tools, clamping shells and tubes
- Preparation of thin-walled stainless steel tubes (V4A)
- High-performance coated tool bit with two cutting edges
- Built-in electronic speed regulation
- Micrometer feed for optimum results
- No additional tools required for operation
- Space saving, light weight and portable machine for a mobile and secure application



RPG 4.5



RPG 8.6

RPG 4.5, RPG 8.6

Designed for burr-free squaring of thin-walled stainless steel tubes.

Clean and secure working area with a clear view of the cutting head.

Machine with rotating/removable bench stand.

Machine comes with:

- 1 Tube Squaring Machine RPG 4.5 or RPG 8.6
- 1 Durable storage and shipping case
- 1 Tool holder (Code 790 038 320) with multifunctional tool (Code 790 038 314)
- 1 Tool set
- 1 Set of operating instructions and spare parts list

Application range	RPG 4.5	RPG 8.6
Tube OD	12.7 - 114.3 mm 0.5 - 4.5 inch	50.8 - 219.1 mm 2 - 8.6 inch
Wall thickness max.	3.0 mm 0.118 inch	3.6 mm 0.142 inch
Tube materials	High-alloy steels, unalloyed and low-alloy steels and aluminum. Others on request.	
Technical data	Electric drive with single-phase AC motor	
Dimensions (including motor)	525 x 256 x 226 mm 20.7 x 10 x 8.9 inch	630 x 390 x 340 mm 24.8 x 15.4 x 13.4 inch
Power	1100 W	1100 W
Protection class	II	II
Built-in electronic variable cutting speed	8 - 52 min ⁻¹	7 - 18 min ⁻¹
Vibration level according to EN 28662, Part 1	2.5 m/s ²	2.5 m/s ²
Noise level at the workplace	Idle running approx. 83 dB (A)	Idle running approx. 83 dB (A)

Article	Version	Code	Weight of machine kg	Dispatch weight kg
RPG 4.5	230 V, 50/60 Hz EU	790 038 001	10.500	19.400
RPG 4.5	110 V, 50/60 Hz EU	790 038 003	10.500	19.400
RPG 4.5	120 V, 50/60 Hz US	790 038 002	10.500	19.400
RPG 8.6	230 V, 50/60 Hz EU	790 039 001	20.500	32.000
RPG 8.6	110 V, 50/60 Hz EU	790 039 003	20.500	32.000
RPG 8.6	120 V, 50/60 Hz US	790 039 002	20.500	32.000

Accessories for RPG 4.5, RPG 8.6

Please check the outer diameter of the tubes before ordering the clamping shells.

Clamping shells

Extremely durable. The two-piece-design with click mechanism ensures accurate centering and quick clamping shell change without any tools. Further dimensions of clamping shells are available.

Applicable with	Version	Tube OD [mm]	Tube OD [inch]	Code	kg
RPG 4.5	Stainless steel	12.00	0.472	790 038 454	2.170
RPG 4.5	Stainless steel	12.70	0.500	790 038 438	2.177
RPG 4.5	Stainless steel	13.00	0.512	790 038 439	2.176
RPG 4.5	Stainless steel	13.50	0.531	790 038 440	2.175
RPG 4.5	Stainless steel	14.00	0.551	790 038 441	2.174
RPG 4.5	Stainless steel	16.00	0.630	790 038 442	2.168
RPG 4.5	Stainless steel	17.20	0.677	790 038 443	2.164
RPG 4.5	Stainless steel	18.00	0.709	790 038 444	2.161
RPG 4.5	Stainless steel	19.00	0.748	790 038 445	2.150
RPG 4.5	Stainless steel	19.05	0.750	790 038 446	2.157
RPG 4.5	Stainless steel	20.00	0.787	790 038 447	2.153
RPG 4.5	Stainless steel	21.30	0.839	790 038 448	2.100
RPG 4.5	Stainless steel	22.00	0.866	790 038 449	2.144
RPG 4.5	Stainless steel	22.22	0.875	790 038 050	2.195
RPG 4.5	Stainless steel	23.00	0.906	790 038 450	2.140
RPG 4.5	Stainless steel	24.00	0.945	790 038 451	2.133
RPG 4.5	Stainless steel	25.00	0.984	790 038 452	2.127
RPG 4.5	Stainless steel	25.25	0.994	790 038 049	2.180
RPG 4.5	Stainless steel	25.40	1.000	790 038 051	2.100
RPG 4.5	Stainless steel	26.90	1.059	790 038 400	2.090
RPG 4.5	Stainless steel	27.20	1.071	790 038 468	2.165
RPG 4.5	Stainless steel	28.00	1.102	790 038 401	2.110
RPG 4.5	Stainless steel	29.00	1.142	790 038 402	2.105
RPG 4.5	Stainless steel	30.00	1.181	790 038 403	2.095
RPG 4.5	Stainless steel	31.75	1.250	790 038 052	2.090
RPG 4.5	Stainless steel	31.80	1.252	790 038 404	2.080
RPG 4.5	Stainless steel	32.00	1.260	790 038 455	2.080
RPG 4.5	Stainless steel	33.00	1.299	790 038 465	2.120
RPG 4.5	Stainless steel	33.40	1.315	790 038 405	2.040
RPG 4.5	Stainless steel	33.70	1.327	790 038 406	2.060
RPG 4.5	Stainless steel	34.00	1.339	790 038 407	2.040
RPG 4.5	Stainless steel	35.00	1.378	790 038 408	2.050
RPG 4.5	Stainless steel	36.00	1.417	790 038 409	2.044
RPG 4.5	Stainless steel	38.00	1.496	790 038 410	2.025
RPG 4.5	Stainless steel	38.10	1.500	790 038 053	2.020
RPG 4.5	Stainless steel	40.00	1.575	790 038 411	2.000
RPG 4.5	Stainless steel	41.00	1.614	790 038 412	1.990
RPG 4.5	Stainless steel	42.00	1.654	790 038 413	1.976
RPG 4.5	Stainless steel	42.16	1.660	790 038 414	1.950
RPG 4.5	Stainless steel	42.40	1.669	790 038 415	1.965
RPG 4.5	Stainless steel	42.70	1.681	790 038 416	1.950
RPG 4.5	Stainless steel	44.45	1.750	790 038 417	1.955
RPG 4.5	Stainless steel	44.50	1.752	790 038 418	1.955
RPG 4.5	Stainless steel	45.00	1.772	790 038 419	1.948
RPG 4.5	Stainless steel	48.00	1.890	790 038 464	1.960
RPG 4.5	Stainless steel	48.26	1.900	790 038 420	1.880
RPG 4.5	Stainless steel	48.30	1.902	790 038 421	1.905
RPG 4.5	Stainless steel	48.60	1.913	790 038 422	1.875
RPG 4.5	Stainless steel	50.00	1.969	790 038 456	1.880
RPG 4.5	Stainless steel	50.80	2.000	790 038 054	1.895
RPG 4.5	Stainless steel	51.00	2.008	790 038 423	1.870
RPG 4.5	Stainless steel	52.00	2.047	790 038 424	1.850
RPG 4.5	Stainless steel	53.00	2.087	790 038 425	1.835
RPG 4.5	Stainless steel	54.00	2.126	790 038 426	1.827
RPG 4.5	Stainless steel	57.00	2.244	790 038 457	1.780



Clamping shells for RPG 4.5



Aluminum clamping shells for RPG 8.6

Applicable with	Version	Tube OD [mm]	Tube OD [inch]	Code	kg
RPG 4.5	Stainless steel	60.00	2.362	790 038 469	1.780
RPG 4.5	Stainless steel	60.30	2.375	790 038 427	1.700
RPG 4.5	Stainless steel	60.45	2.380	790 038 428	1.726
RPG 4.5	Stainless steel	60.50	2.382	790 038 429	1.695
RPG 4.5	Stainless steel	63.00	2.480	790 038 461	1.688
RPG 4.5	Stainless steel	63.50	2.500	790 038 055	1.670
RPG 4.5	Stainless steel	65.00	2.559	790 038 463	1.700
RPG 4.5	Stainless steel	70.00	2.756	790 038 430	1.545
RPG 4.5	Stainless steel	73.03	2.875	790 038 453	1.485
RPG 4.5	Stainless steel	73.15	2.880	790 038 431	1.482
RPG 4.5	Stainless steel	75.00	2.953	790 038 462	1.443
RPG 4.5	Stainless steel	76.10	2.996	790 038 432	1.420
RPG 4.5	Stainless steel	76.20	3.000	790 038 056	1.390
RPG 4.5	Stainless steel	76.30	3.004	790 038 433	1.390
RPG 4.5	Stainless steel	80.00	3.150	790 038 466	1.390
RPG 4.5	Stainless steel	85.00	3.346	790 038 434	1.220
RPG 4.5	Stainless steel	85.90	3.382	790 038 435	1.200
RPG 4.5	Stainless steel	88.90	3.500	790 038 057	1.130
RPG 4.5	Stainless steel	89.10	3.508	790 038 436	1.100
RPG 4.5	Stainless steel	90.00	3.543	790 038 467	1.150
RPG 4.5	Stainless steel	101.60	4.000	790 038 058	0.800
RPG 4.5	Stainless steel	104.00	4.094	790 038 437	0.740
RPG 4.5	Stainless steel	108.00	4.252	790 038 458	0.620
RPG 4.5	Stainless steel	114.30	4.500	790 038 059	0.435
RPG 8.6	Aluminum	50.80	2.000	790 039 260	3.800
RPG 8.6	Aluminum	57.00	2.244	790 039 265	4.000
RPG 8.6	Aluminum	76.20	3.000	790 039 261	4.200
RPG 8.6	Aluminum	88.90	3.500	790 039 264	4.000
RPG 8.6	Aluminum	101.60	4.000	790 039 252	3.800
RPG 8.6	Aluminum	108.00	4.252	790 039 266	4.850
RPG 8.6	Aluminum	114.30	4.500	790 039 256	3.500
RPG 8.6	Aluminum	127.05	5.002	790 039 262	3.420
RPG 8.6	Aluminum	133.00	5.236	790 039 267	4.600
RPG 8.6	Aluminum	139.70	5.500	790 039 259	3.100
RPG 8.6	Aluminum	141.30	5.563	790 039 257	2.900
RPG 8.6	Aluminum	152.40	6.000	790 039 253	2.700
RPG 8.6	Aluminum	159.00	6.260	790 039 268	4.200
RPG 8.6	Aluminum	168.30	6.625	790 039 254	2.300
RPG 8.6	Aluminum	193.70	7.626	790 039 269	3.500
RPG 8.6	Aluminum	197.00	7.756	790 039 263	1.530
RPG 8.6	Aluminum	203.20	8.000	790 039 258	3.500
RPG 8.6	Aluminum	219.10	8.625	790 039 255	0.600
RPG 8.6	Stainless steel	101.60	4.000	790 039 287	5.000
RPG 8.6	Stainless steel	114.30	4.500	790 039 280	4.700
RPG 8.6	Stainless steel	141.30	5.563	790 039 281	4.500
RPG 8.6	Stainless steel	152.40	6.000	790 039 283	4.400
RPG 8.6	Stainless steel	168.30	6.625	790 039 284	4.000
RPG 8.6	Stainless steel	203.20	8.000	790 039 286	3.240
RPG 8.6	Stainless steel	219.10	8.625	790 039 285	1.500

Tool holder WH

Fits multifunctional tool 790 038 314. Incl. Torx fixing screw.

Application range	Possible application		Beveling angle
	Squaring	Beveling	[°]
Tool holder WH15-I	x	–	–
Tool holder WH12-V-45°	–	x	45
Tool holder WH12-V-35°	–	x	35
Tool holder WH12-U-20°	–	x	20

Article	Code	kg
Tool holder WH15-I	790 038 320	0.025
Tool holder WH12-V-45°	790 038 280	0.044
Tool holder WH12-V-35°	790 038 282	0.054
Tool holder WH12-U-20°	790 038 326	0.031



Tool holder WH

Multifunctional tool MFW

Two-sided tool bit with high-performance Balinit® Futura protective coating against tool wear. Usable for all machines of the RPG series.

Article	Quantity	Code	kg
Multifunctional tool MFW-P-2	1	790 038 314	0.003
Multifunctional tool MFW-P-2	10	790 038 315	0.045



Multifunctional tool MFW



Powerful and robust boiler pipe preparation machine!



BRB Pneumatic/Auto with pneumatic clamping, ideal for series processing



The "NC" clamping system never loses grip thanks to clamping wedges firmly anchored in the mandrel



Optimized electric motor – the BRB 2 will also soon be available as an electric model



Holder for balancer allows work to be carried out quickly and effortlessly



Optimum performance with the low weight

Boiler Pipe Preparation Machines BRB

- Handy and compact design
- Precise and reproducible weld preparation
- Fast application with the BRB Pneumatic/Auto by means of pneumatic clamping, ideal for continuous production e.g. boiler and heat exchanger applications
- High performance and lightweight
- High-performance coated tool bits with up to 4 cutting edges
- Quick clamping system for tools with easy adjustment
- Adjustable air outlet
- Easy to change tools
- Tools adaptable on all BRB machines
- Possibility to retrofit to previous BRB models to BRB Pneumatic/Auto and to the new clamping system "NC"
- Up to 3 tools can be used at the same time

Powerful and robust Boiler Prep Machine. Counterboring and axial turning of pipes made from high-alloy steel (stainless steel), low-alloy and carbon steel with the unique tool system QTC®. Designed for pipe end preparations and boiler pipe applications.

The BRB machines are available in the following **drive versions**:

- **Electric:** 230 V, 50/60 Hz EU or 120 V, 50/60 Hz EU/US
Electric drive with single-phase AC motor, protection class II (double insulated), Built-in electronic variable cutting speed
- **Pneumatic:** Pneumatic power drive. Manufacturer's warranty can only be given when using a mobile air unit. We recommend the mobile air unit from Orbitalum Tools, Code 790 093 060 (see page 65).
- **Pneumatic/Auto:** Pneumatic multi-disc motor with additional pneumatic clamping system. Time is of the essence when installing or repairing boiler pipes, the new pneumatic clamping system greatly reduces the time to both clamp and release the machine, improving efficiency. The machine centers itself on the inside diameter of the pipe and then clamps automatically by using the toggle switch, likewise the toggle switch releases the clamping after the machining operation. This is why the BRB with automatic pneumatic clamping is ideal for continuous production e.g. boiler and heat exchanger applications.

Technical data	BRB 2 Electric	BRB 2 Pneumatic	BRB 2 Pneu/Auto	BRB 4 Electric	BRB 4 Pneumatic	BRB 4 Pneu/Auto
Power	0.5 kW	0.38 kW	0.38 kW	1.5 kW	1.0 kW	1.0 kW
Speed	18 - 118 rpm	0 - 120 rpm	0 - 120 rpm	12 - 37 rpm	0 - 110 rpm	0 - 110 rpm
Air supply requirement (at 6 bar)	–	0.7 m ³ /min	0.7 m ³ /min	–	1.0 m ³ /min	1.0 m ³ /min
Noise level LAeq 1 m (EN 23741), approx.	76 dB (A)	82 dB (A)	82 dB (A)	82 dB (A)	84 dB (A)	84 dB (A)
Vibration level (EN 28662, part 1)	2.5 m/s ²	2.5 m/s ²	2.5 m/s ²	2.5 m/s ²	2.5 m/s ²	2.5 m/s ²

Please choose before ordering the above mentioned BRB drive version one of the following **clamping systems**:

- Standard clamping system (see page 52)
- NC clamping system (see page 54)

All BRB machines come with:

- 1 Boiler Pipe Preparation Machine BRB 2 or BRB 4
- 1 Durable storage and shipping case
- Tool retainer, clamping sets, mandrels, application kits (tables see page 52 and page 54).
- 1 KSS-TOP lubricant spray pump (Code 790 060 226)
- 1 Tool set
- 1 Set of operating instructions and spare parts list

BRB with clamping system “Standard”

BRB 4 with clamping system “NC” see page 54.

A detailed description of the machine, technical specifications and scope of delivery see on page 50. Please specify the required clamping system (“Standard” or “NC”), the application kit (Kit 1 to Kit 5) as well as the drive version (Electric, Pneumatic or Pneumatic/Auto) with your purchase order.

Application range	BRB 2		BRB 4					
	Kit 1	Kit 2	Kit 1	Kit 2	Kit 3	Kit 4	Kit 5	
Pipe ID (Ø)	[mm]	12.75 - 25.5	19.1 - 46.0	19.1 - 33.8	32.0 - 61.7	32.0 - 110.8	19.1 - 61.7	19.1 - 110.8
clamping range)	[inch]	0.502 - 1.004	0.752 - 1.811	0.752 - 1.330	1.260 - 2.429	1.260 - 4.370	0.752 - 2.429	0.752 - 4.362
Tool retainer Ø	[mm]	50.0 / 12.75	50.0 / 16.0	68.0 / 19.0	68.0 / 27.0	120.0 / 27.0	68.0 / 19.0 68.0 / 27.0	68.0 / 19.0 68.0 / 27.0 120.0 / 27.0
	[inch]	1.969 / 0.502	1.969 / 0.630	2.677 / 0.748	2.677 / 1.063	4.724 / 1.063	2.677 / 0.748 2.677 / 1.063	2.677 / 0.748 2.677 / 1.063 4.724 / 1.063
Clamping wedges	[Sets]	6	8	4	3	6	7	10
Mandrel Ø	[mm]	12.75	19.05	19.05	31.5	31.5	19.05 31.5	19.05 31.5
	[inch]	0.502	0.750	0.750	1.240	1.240	0.750 1.240	0.750 1.240
Pipe OD	[mm]	16.75 - 41.5	23.0 - 62.0	64.0	73.0	114.3	73.0	114.3
	[inch]	0.659 - 1.634	0.906 - 2.441	2.51	2.87	4.50	2.87	4.50
Wall thickness*	[mm]	2 - 8	2 - 8	2 - 15	2 - 15	2 - 15	2 - 15	2 - 15
min. - max.	[inch]	0.079 - 0.315	0.079 - 0.315	0.079 - 0.590	0.079 - 0.590	0.079 - 0.590	0.079 - 0.590	0.079 - 0.590

* depending on pipe material and dimension

Article	Version	Clamping system	Code	Weight of machine kg	Dispatch weight kg
BRB 2 EL, Kit 1	230 V, 50/60 Hz EU	Standard	790 085 011		12.200
BRB 2 EL, Kit 2	230 V, 50/60 Hz EU	Standard	790 085 012		12.000
BRB 2 EL, Kit 1	120 V, 50/60 Hz EU/US	Standard	790 085 021		
BRB 2 EL, Kit 2	120 V, 50/60 Hz EU/US	Standard	790 085 022		
BRB 2 Pneumatic, Kit 1	Pneumatic	Standard	790 085 007		11.900
BRB 2 Pneumatic, Kit 2	Pneumatic	Standard	790 085 008		12.300
BRB 2 Pneu/Auto, Kit 1	Pneumatic/Auto	Standard	790 085 041		13.300
BRB 2 Pneu/Auto, Kit 2	Pneumatic/Auto	Standard	790 085 042		13.500
BRB 4 EL, Kit 1	230 V, 50/60 Hz EU	Standard	790 086 011		15.000
BRB 4 EL, Kit 2	230 V, 50/60 Hz EU	Standard	790 086 012		16.000
BRB 4 EL, Kit 3	230 V, 50/60 Hz EU	Standard	790 086 013		22.800
BRB 4 EL, Kit 4	230 V, 50/60 Hz EU	Standard	790 086 014		18.000
BRB 4 EL, Kit 5	230 V, 50/60 Hz EU	Standard	790 086 015		19.000
BRB 4 EL, Kit 1	120 V, 50/60 Hz EU/US	Standard	790 086 021		15.000
BRB 4 EL, Kit 2	120 V, 50/60 Hz EU/US	Standard	790 086 022		16.000
BRB 4 EL, Kit 3	120 V, 50/60 Hz EU/US	Standard	790 086 023		18.500
BRB 4 EL, Kit 4	120 V, 50/60 Hz EU/US	Standard	790 086 024		18.000
BRB 4 EL, Kit 5	120 V, 50/60 Hz EU/US	Standard	790 086 025		19.000
BRB 4 Pneumatic, Kit 1	Pneumatic	Standard	790 086 001		14.000
BRB 4 Pneumatic, Kit 2	Pneumatic	Standard	790 086 002		15.000
BRB 4 Pneumatic, Kit 3	Pneumatic	Standard	790 086 003		17.000
BRB 4 Pneumatic, Kit 4	Pneumatic	Standard	790 086 004		16.600
BRB 4 Pneumatic, Kit 5	Pneumatic	Standard	790 086 005		23.700
BRB 4 Pneu/Auto, Kit 1	Pneumatic/Auto	Standard	790 086 031		
BRB 4 Pneu/Auto, Kit 2	Pneumatic/Auto	Standard	790 086 032		
BRB 4 Pneu/Auto, Kit 3	Pneumatic/Auto	Standard	790 086 033		
BRB 4 Pneu/Auto, Kit 4	Pneumatic/Auto	Standard	790 086 034		
BRB 4 Pneu/Auto, Kit 5	Pneumatic/Auto	Standard	790 086 035		24.500



BRB 2 and BRB 4 Electric
with clamping system “Standard”



BRB 2 and BRB 4 Pneumatic
with clamping system “Standard”



BRB 2 and BRB 4 Pneumatic/Auto
with clamping system “Standard”

Retrofit kits BRB Standard “Dimension”

To extend the diameter dimension range of BRB machines.

Retrofit kits “Dimension” for BRB machines with clamping system “NC” see page 55.

Retrofit kits “Dimension” for BRB 4 with drive version Pneumatic/Auto on request.



Retrofit kit BRB Standard “Dimension”

No.	for	Version	Code-No.	For retrofitting	Mandrel Ø		Tool retainer Ø		Extension of dimension to			
					Pipe ID		Pipe OD		Pipe ID		Pipe OD	
					[mm]	[inch]	[mm]	[inch]	[mm]	[inch]	[mm]	[inch]
01	BRB 2	Auto	790 085 016	Kit 2 to Kit 1	12.75	0.500	50.00	1.968	12.75 - 25.5	0.500 - 1.004	16.75 - 41.5	0.659 - 1.634
02	BRB 2	Pneu/EL	790 085 017	Kit 2 to Kit 1	12.75	0.500	50.00	1.968	12.75 - 25.5	0.500 - 1.004	16.75 - 41.5	0.659 - 1.634
03	BRB 2	Pneu/EL	790 085 018	Kit 1 to Kit 2	19.10	0.750	50.00	1.968	19.10 - 46.0	0.750 - 1.811	23.00 - 50.0	0.910 - 1.960
01	BRB 4	Pneu/EL	790 086 051	Kit 1 to Kit 4 / Kit 1 to Kit 2	31.50	1.240	68.0	2.677	19.1 - 61.7	0.752 - 2.429	68.0	2.677
02	BRB 4	Pneu/EL	790 086 052	Kit 1 to Kit 3	31.50	1.240	120.0	4.724	19.1 - 110.8	0.752 - 4.362	114.3	4.500
03	BRB 4	Pneu/EL	790 086 053	Kit 2 to Kit 1 / Kit 3 to Kit 1	19.05	0.750	68.0	2.677	19.1 - 61.7	0.752 - 2.429	68.0	2.677
04	BRB 4	Pneu/EL	790 086 054	Kit 2 to Kit 3 / Kit 4 to Kit 5	-	-	120.0	4.724	32.0 - 110.8	1.260 - 4.362	114.3	4.500
05	BRB 4	Pneu/EL	790 086 055	Kit 1 to Kit 5	31.50	1.240	68.0	2.677	19.1 - 110.8	0.752 - 4.362	114.3	4.500
06	BRB 4	Pneu/EL	790 086 056	Kit 3 to Kit 2	-	-	68.0	2.677	32.0 - 110.8	1.260 - 4.362	114.3	4.500

Article	Version	Code	kg
Retrofit kit BRB 2 Standard/01 "Dimension"	Kit 2 to Kit 1 (Auto)	790 085 016	1.235
Retrofit kit BRB 2 Standard/02 "Dimension"	Kit 2 to Kit 1	790 085 017	0.800
Retrofit kit BRB 2 Standard/03 "Dimension"	Kit 1 to Kit 2	790 085 018	1.235
Retrofit kit BRB 4 Standard/01 "Dimension"	Kit 1 to Kit 4 / Kit 1 to Kit 2	790 086 051	2.600
Retrofit kit BRB 4 Standard/02 "Dimension"	Kit 1 to Kit 3	790 086 052	3.700
Retrofit kit BRB 4 Standard/03 "Dimension"	Kit 2 to Kit 1 / Kit 3 to Kit 1	790 086 053	1.900
Retrofit kit BRB 4 Standard/04 "Dimension"	Kit 2 to Kit 3 / Kit 4 to Kit 5	790 086 054	1.900
Retrofit kit BRB 4 Standard/05 "Dimension"	Kit 1 to Kit 5	790 086 055	4.200
Retrofit kit BRB 4 Standard/06 "Dimension"	Kit 3 to Kit 2	790 086 056	0.700

Retrofit kits BRB Standard “Pneumatic to Auto”

Retrofitting to pneumatic clamping, ideal for continuous production e.g. boiler and heat exchanger applications. Only for pneumatic machine versions. Easy and fast to mount.

The retrofit kit comes with: clamping cylinder complete, spindle complete and feed handle.

BRB retrofit kits for machines with clamping system “NC” see page 55.

Article	Kit	Code	kg
Retrofit kit BRB 2 Standard/01 "Pneumatic to Auto"	Kit 1	790 085 081	-
Retrofit kit BRB 2 Standard/02 "Pneumatic to Auto"	Kit 2	790 085 082	-
Retrofit kit BRB 4 Standard/01 "Pneumatic to Auto"	Kit 1	790 086 081	-
Retrofit kit BRB 4 Standard/02 "Pneumatic to Auto"	Kit 2	790 086 082	-
Retrofit kit BRB 4 Standard/03 "Pneumatic to Auto"	Kit 3	790 086 083	-
Retrofit kit BRB 4 Standard/04 "Pneumatic to Auto"	Kit 4	790 086 084	-
Retrofit kit BRB 4 Standard/05 "Pneumatic to Auto"	Kit 5	790 086 085	-

Retrofit kits BRB "Standard to NC"

Retrofit kits BRB "Standard to NC" for BRB with drive version Pneumatic/Auto on request.

Article	Clamping range Ø		Code		kg
	[mm]	[inch]			
Retrofit kit BRB 2/01 "Standard to NC"	19.1 - 38.0	0.752 - 1.490	790 185 083		-
Retrofit kit BRB 4/01 "Standard to NC"	19.1 - 38.0	0.752 - 1.490	790 186 071		-
Retrofit kit BRB 4/02 "Standard to NC"	35.0 - 64.0	1.378 - 2.520	790 186 072		-
Retrofit kit BRB 4/03 "Standard to NC"	35.0 - 108.0	1.378 - 4.252	790 186 073		-
Retrofit kit BRB 4/04 "Standard to NC"	19.1 - 64.0	0.752 - 2.520	790 186 074		-
Retrofit kit BRB 4/05 "Standard to NC"	19.1 - 108.0	0.752 - 4.252	790 186 075		-

BRB 4 with clamping system "NC"

BRB with clamping system "Standard" see page 52.

The wedges of the new clamping system "NC" are fixed to the mandrel – the ideal solution for applications where foreign particles should not access into the pipe or boiler pipe. Especially when working vertically the "NC" clamping system ensures additional safety.

A detailed description of the machine, technical specifications and scope of delivery see on page 51. Please specify the required clamping system ("Standard" or "NC"), the application kit (Kit 1 to Kit 5) as well as the drive version (Electric, Pneumatic or Pneumatic/Auto) with your purchase order.



BRB 2 and BRB 4 Electric with clamping system "NC"



BRB 2 and BRB 4 Pneumatic with clamping system "NC"



BRB 2 and BRB 4 Pneumatic/Auto with clamping system "NC"

Application rangee		BRB 2		BRB 4				
		Kit 2	Kit 1	Kit 2	Kit 3	Kit 4	Kit 5	
Pipe ID (Ø)	[mm]	19.1 - 38.0	19.1 - 38.0	35.0 - 64.0	35.0 - 108.0	19.1 - 64.0	19.1 - 108.0	
clamping range)	[inch]	0.752 - 1.490	0.752 - 1.490	1.378 - 2.520	1.378 - 4.252	0.752 - 2.520	0.752 - 4.252	
Tool retainer Ø	[mm]	50.0 / 16.0	68.0 / 19.0	68.0 / 27.0	120.0 / 27.0	68.0 / 19.0 68.0 / 27.0	68.0 / 19.0 68.0 / 27.0 120.0 / 27.0	
	[inch]	1.969 - 0.630	2.677 / 0.748	2.677 / 1.063	4.724 / 1.063	2.677 / 0.748 2.677 / 1.063	2.677 / 0.748 2.677 / 1.063 4.724 / 1.063	
Clamping wedges	[Sets]	6	6	7	18 (8+10)	13	24 (14+10)	
Mandrel Ø	[mm]	19.05	19.05	34.5	34.5	19.05 34.5	19.05 34.5	
	[inch]	0.750	0.750	1.358	1.358	0.750 1.358	0.750 1.358	
Pipe OD	[mm]	23.0 - 62.0	64.0	73.0	114.3	73.0	114.3	
	[inch]	0.906 - 2.441	2.51	2.87	4.50	2.87	4.50	
Wall thickness*	[mm]	2 - 8	2 - 15	2 - 15	2 - 15	2 - 15	2 - 15	
min. - max.	[inch]	0.079 - 0.315	0.079 - 0.590	0.079 - 0.590	0.079 - 0.590	0.079 - 0.590	0.079 - 0.590	

* depending on pipe material and dimension

Article	Version	Clamping system	Code	Weight of machine kg	Dispatch weight kg
BRB 2 EL, Kit 2	230 V, 50/60 Hz EU	NC	790 185 012		13.000
BRB 2 EL, Kit 2	120 V, 50/60 Hz EU/US	NC	790 185 022		13.000
BRB 2 Pneumatic, Kit 2	Pneumatic	NC	790 185 002		12.500
BRB 2 Pneu/Auto, Kit 2	Pneumatic/Auto	NC	790 185 042		13.800
BRB 4 EL, Kit 1	230 V, 50/60 Hz EU	NC	790 186 011		
BRB 4 EL, Kit 2	230 V, 50/60 Hz EU	NC	790 186 012		
BRB 4 EL, Kit 3	230 V, 50/60 Hz EU	NC	790 186 013		23.300
BRB 4 EL, Kit 4	230 V, 50/60 Hz EU	NC	790 186 014		25.200
BRB 4 EL, Kit 5	230 V, 50/60 Hz EU	NC	790 186 015		26.400
BRB 4 EL, Kit 1	120 V, 50/60 Hz EU/US	NC	790 186 021		
BRB 4 EL, Kit 2	120 V, 50/60 Hz EU/US	NC	790 186 022		
BRB 4 EL, Kit 3	120 V, 50/60 Hz EU/US	NC	790 186 023		
BRB 4 EL, Kit 4	120 V, 50/60 Hz EU/US	NC	790 186 024		
BRB 4 EL, Kit 5	120 V, 50/60 Hz EU/US	NC	790 186 025		26.000
BRB 4 Pneumatic, Kit 1	Pneumatic	NC	790 186 001		19.500
BRB 4 Pneumatic, Kit 2	Pneumatic	NC	790 186 002		
BRB 4 Pneumatic, Kit 3	Pneumatic	NC	790 186 003		22.200
BRB 4 Pneumatic, Kit 4	Pneumatic	NC	790 186 004		
BRB 4 Pneumatic, Kit 5	Pneumatic	NC	790 186 005		25.500
BRB 4 Pneu/Auto, Kit 1	Pneumatic/Auto	NC	790 186 031		
BRB 4 Pneu/Auto, Kit 2	Pneumatic/Auto	NC	790 186 032		
BRB 4 Pneu/Auto, Kit 3	Pneumatic/Auto	NC	790 186 033		23.400
BRB 4 Pneu/Auto, Kit 4	Pneumatic/Auto	NC	790 186 034		
BRB 4 Pneu/Auto, Kit 5	Pneumatic/Auto	NC	790 186 035		26.000

Retrofit kits BRB 4 NC “Dimension”

To extend the diameter dimension range of BRB 4 machines.

Retrofit kits “Dimension” for BRB 4 machines with clamping system “Standard” see page 53. Retrofit kits “Dimension” for BRB with drive version Pneumatic/Auto on request.

No.	Code-No.	For retrofitting	Mandrel Ø		Tool retainer Ø		Extension of dimension to			
							Pipe ID		Pipe OD	
			[mm]	[inch]	[mm]	[inch]	[mm]	[inch]	[mm]	[inch]
10	790 186 051	Kit 1 to Kit 4 / Kit 1 to Kit 2	34.50	1.358	68.0	2.677	19.1 - 64.0	0.752 - 2.520	68.0	2.677
11	790 186 052	Kit 1 to Kit 3	34.50	1.358	120.0	4.724	19.1 - 108.0	0.752 - 4.252	114.3	4.500
12	790 186 053	Kit 2 to Kit 1 / Kit 3 to Kit 1	19.05	0.750	68.0	2.677	19.1 - 64.0	0.752 - 2.520	68.0	2.677
13	790 186 054	Kit 2 to Kit 3 / Kit 4 to Kit 5	-	-	120.0	4.724	35.0 - 108.0	1.378 - 4.252	114.3	4.500
14	790 186 055	Kit 1 to Kit 5	34.50	1.358	68.0	2.677 120.0 4.724	19.1 - 108.0	0.752 - 4.252	114.3	4.500
15	790 186 056	Kit 3 to Kit 2	-	-	68.0	2.677	35.0 - 108.0	1.378 - 4.252	114.3	4.500

Article	Version	Code	kg
Retrofit kit BRB 4 NC/10 "Dimension"	Kit 1 to Kit 4 / Kit 1 to Kit 2	790 186 051	-
Retrofit kit BRB 4 NC/11 "Dimension"	Kit 1 to Kit 3	790 186 052	-
Retrofit kit BRB 4 NC/12 "Dimension"	Kit 2 to Kit 1 / Kit 3 to Kit 1	790 186 053	-
Retrofit kit BRB 4 NC/13 "Dimension"	Kit 2 to Kit 3 / Kit 4 to Kit 5	790 186 054	-
Retrofit kit BRB 4 NC/14 "Dimension"	Kit 1 to Kit 5	790 186 055	-
Retrofit kit BRB 4 NC/15 "Dimension"	Kit 3 to Kit 2	790 186 056	-

Retrofit kits BRB NC “Pneumatic to Auto”

Retrofitting to pneumatic clamping, ideal for continuous production e.g. boiler and heat exchanger applications. Only for pneumatic machine versions. Easy and fast to mount.

The retrofit kit comes with: clamping cylinder complete, spindle complete and feed handle. BRB retrofit kits for machines with clamping system “Standard” see page 53.

Article	Kit	Code	kg
Retrofit kit BRB 2 NC/03 "Pneumatic to Auto"	Kit 2	790 185 082	-
Retrofit kit BRB 4 NC/10 "Pneumatic to Auto"	Kit 1	790 186 081	-
Retrofit kit BRB 4 NC/11 "Pneumatic to Auto"	Kit 2	790 186 082	-
Retrofit kit BRB 4 NC/12 "Pneumatic to Auto"	Kit 3	790 186 083	-
Retrofit kit BRB 4 NC/13 "Pneumatic to Auto"	Kit 4	790 186 084	-
Retrofit kit BRB 4 NC/14 "Pneumatic to Auto"	Kit 5	790 186 085	-

Brush attachments

For BRB 4 machines. These new brush attachments made from brass prevent swarf and any other foreign materials entering the pipe, especially when using the machine vertically. The brushes can be mounted quickly and easily to the threaded spindle of the new BRB 4 models. The new threaded spindle can be retrofitted to machines manufactured up to October 2009. The brushes are applicable for both clamping systems (Standard/NC).

1 packaging unit = 5 brushes. Price per packaging unit. Weight per brush attachment.

Further dimensions on request.



Brush attachment

Article	Brush adapter			Pipe ID min.-max.		Code		kg
	10	25	33	[mm]	[inch]			
Brush M8/25*	-	-	-	19.1 - 24.3	0.752 - 0.957	790 086 520		-
Brush M8/28*	-	-	-	22.1 - 27.3	0.870 - 1.075	790 086 521		-
Brush M8/31*	-	-	-	25.5 - 30.8	1.004 - 1.213	790 086 522		-
Brush M8/34*	-	-	-	28.5 - 33.8	1.122 - 1.331	790 086 523		-
Brush adapter 10	x	-	-	-	-	790 086 497		-
Brush 10/43	x	-	-	32.0 - 42.1	1.260 - 1.657	790 086 524		-
Brush 10/53	x	-	-	40.9 - 52.0	1.610 - 2.047	790 086 525		-
Brush adapter 25	-	x	-	-	-	790 086 498		-
Brush 25/62,5	-	x	-	50.7 - 61.7	1.996 - 2.429	790 086 526		-
Brush 25/71	-	x	-	59.4 - 70.4	2.339 - 2.772	790 086 527		-
Brush 25/81	-	x	-	69.2 - 80.2	2.724 - 3.157	790 086 528		-
Brush adapter 33	-	-	x	-	-	790 086 499		-
Brush 33/91	-	-	x	79.6 - 90.5	3.134 - 3.563	790 086 529		-
Brush 33/101	-	-	x	89.4 - 100.4	3.520 - 3.953	790 086 530		-
Brush 33/112	-	-	x	99.6 - 110.8	3.921 - 4.362	790 086 531		-

* Comes with the suitable adapter.

** When ordering, please indicate the inside diameter of the pipe to be worked on. The brush comes with a suitable adapter.

Initial equipment kit of brushes for BRB 4

Including all above listed adapters and brushes (1 brush of each dimension).

Article	Brush adapter			Pipe ID min.-max.		Code		kg
	10	25	33	[mm]	[inch]			
Initial equipment kit of brushes for BRB 4	x	x	x	19.1 - 110.8	0.752 - 4.362	790 086 535		-

Machines manufactured up to October 2009 can be used with brushes by upgrading with one of the following threaded spindles:

Article	Code	kg
Threaded spindle for mandrel 19.05 / BRB 4	790 086 190	0.136
Threaded spindle for mandrel 31.50 / BRB 4	790 086 160	0.100



Hoist bracket

Hoist bracket

Designed for use with a hoist.

BRB machines which have been manufactured up to October 2009 can be retrofitted with this hoist bracket; all new models are already equipped with the hoist bracket.

Article	Code	kg
Hoist bracket for BRB 4	790 086 310	0.270
Hoist bracket for BRB 2	790 085 310	0.185



Bevel cutter head for BRB 2

Bevel cutter head for BRB 2 (V-/Y-prep)

Optimized work, smoother and steadier cutting. Including adjustable tool holder.

The bevel cutter heads can be replaced like a tool mounting plate. They are available for several prep angles. The bevel cutter heads can be adapted to all machines (even older models).

Comes with:

- 3 multifunctional tools (MFW-12-V/I-2, Code 790 086 060)
- 1 multifunctional tool (MFW5-U/I-2, Code 790 085 030)
- 4 Torx screws
- 3 fastening screws M5x16

Article	Application range				Code	kg
	Kit 1 (ID min. – OD max.)		Kit 2 (ID min. – OD max.)			
	[mm]	[inch]	[mm]	[inch]		
Bevel cutter head 30°	14.5 - 48.0	0.570 - 1.890	–	–	790 085 380	–
Bevel cutter head 37.5°	14.5 - 48.0	0.570 - 1.890	–	–	790 085 381	–
Bevel cutter head 45°	14.5 - 48.0	0.570 - 1.890	–	–	790 085 382	–
Bevel cutter head 30°	–	–	18.0 - 44.0	0.708 - 1.732	790 085 383	–
Bevel cutter head 37.5°	–	–	18.0 - 44.0	0.708 - 1.732	790 085 384	–
Bevel cutter head 45°	–	–	18.0 - 44.0	0.708 - 1.732	790 085 385	–



Bevel cutter head for BRB 4

Bevel cutter head for BRB 4 (V-prep)

The bevel cutter heads with 3 cutting edges provide considerable advantages for heavy chip removal, e.g. for welded material. The bevel cutter heads can be replaced like a tool mounting plate. They are available for various prep angles and can be adapted to all machines (even older models).

Comes with:

- 3 multifunctional tools: MFW-12-V/I-2, Code 790 086 060
MFW-P-2, Code 790 038 314 on request
- 3 Torx screws
- 3 fastening screws M6x16

Article	Application range	Pipe wall thickness max.		Code	kg
		[mm]	[inch]		
Bevel cutter head 30°	ID 36 mm to OD 78 mm (1.417 - 3.071 inch) in 3 steps of 5 mm (0.197 inch) distance	10	0.394	790 086 500	0.465
Bevel cutter head 45°	ID 45 mm to OD 73 mm (1.772 - 2.874 inch) in 2 steps of 5 mm (0.197 inch) distance	10	0.394	790 086 459	0.515

Adjustable spacer

For BRB machines. The adjustable spacer ensures a constant and repeatable depth machining of boiler pipes, etc.

Article	Code		kg
Adjustable spacer for BRB 4	790 086 045		1.285
Adjustable spacer for BRB 2	790 085 055		-



Adjustable spacer

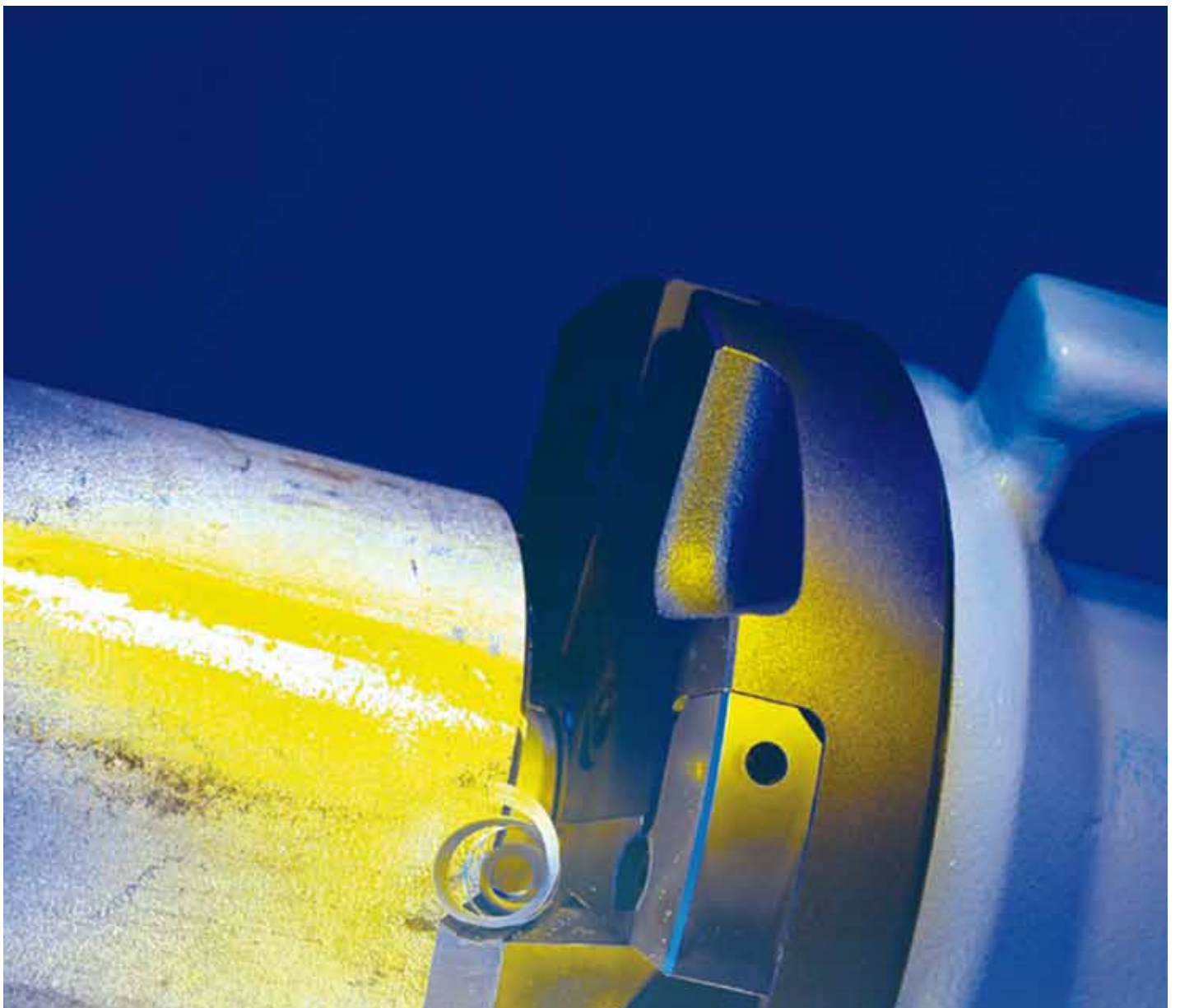

The powerful pipe end preparation solution!



Quick-Tool-Change QTC®



Fast adjustment of the pipe dimension



Portable with an integral carrying handle



Sturdy construction



Compact design for precise and reproducible weld prep profiles

60

Pipe End Preparation Machines REB

Pipe End Preparation Machines

- Compact design for precise and reproducible weld prep profiles
- Quick-Tool-Change QTC®
- Square and burr-free
- High-performance coated tool bit with two or four cutting edges
- Sturdy construction
- Tools adaptable on all REB machines
- Optimized performance and ergonomic drive system
- Portable with an integral carrying handle

REB 6, REB 14, REB 20

The powerful pipe end preparation solution. Counterboring and axial turning of pipes made from high-alloy steel (stainless steel), low-alloy and carbon steel with the unique tool system QTC®. Up to 4 tools can be used at the same time.

Machine comes with:

- 1 Pipe End Preparation Machine REB 6, REB 14 or REB 20
- 1 Transportation case
- 1 Clamping chuck (REB 6 and REB 14) or 2 clamping chucks (REB 20)
- 5 Clamping sets, each with 3 clamping wedges (REB 6) or 6 Clamping sets, each with 3 clamping wedges (REB 14 and REB 20)
- 1 Tool set
- 1 KSS-TOP lubricant spray pump (Code 790 060 226)
- 1 Set of operating instructions and spare parts list

Manufacturer's warranty can only be given when using a mobile air unit. We recommend the mobile air unit from Orbitalum Tools, Code 790 093 060 (see page 65).



REB 6 Electric



REB 14 Pneumatic



REB 20 Pneumatic

Application range*	REB 6 Pneumatic	REB 6 Electric	REB 14 Pneumatic	REB 14 Electric	REB 20 Pneumatic
Pipe ID	49 - 159 mm 1.93 - 6.26 inch	49 - 159 mm 1.93 - 6.26 inch	92 - 320 mm 3.62 - 12.60 inch	92 - 320 mm 3.62 - 12.60 inch	282 - 500 mm 11.10 - 19.69 inch
Wall thickness	3 - 22 mm 0.12 - 0.87 inch	3 - 22 mm 0.12 - 0.87 inch	4 - 30 mm 0.16 - 1.18 inch	4 - 22 mm 0.16 - 0.87 inch	4 - 10 mm 0.16 - 0.39 inch
Pipe OD	56 - 168 mm 2.20 - 6.61 inch	56 - 168 mm 2.20 - 6.61 inch	100 - 355.6 mm 3.94 - 14.00 inch	100 - 355.6 mm 3.94 - 14.00 inch	290 - 508 mm 11.42 - 20 inch
Pipe materials	Unalloyed and low-alloyed steels, high-alloyed steels (stainless steel), aluminum				
Technical data					
Dimensions	560 x 260 x 400 mm 22 x 10.2 x 15.8 inch	640 x 260 x 420 mm 25.2 x 10.2 x 16.5 inch	625 x 375 x 490 mm 24.6 x 14.8 x 19.3 inch	700 x 375 x 510 mm 27.6 x 14.8 x 20 inch	700 x 510 x 570 mm 27.6 x 20 x 22.4 inch
Power	1.8 kW	1.2 kW	1.8 kW	1.2 kW	1.8 kW
Air consumption (at 6 bar)	2.0 m³/min	–	2.0 m³/min	–	2.0 m³/min
Speed	0 - 26 min ⁻¹	10 - 32 min ⁻¹	0 - 13 min ⁻¹	5 - 16 min ⁻¹	0 - 13 min ⁻¹
Vibration level according to EN 28662, Part 1	< 2.5 m/s ²	< 2.5 m/s ²	< 2.5 m/s ²	< 2.5 m/s ²	< 2.5 m/s ²
Noise level in the workplace	at idle-speed: approx. 75 dB (A) (average speed range); under load: approx. 77 dB (A)				

* It is possible to extend the dimensions by using the optional clamping wedges (accessories).

Article	Version	Code	Weight of machine kg	Dispatch weight kg
REB 6	Pneumatic	790 093 001	32.000	52.000
REB 6	230 V, 50/60 Hz EU	790 093 002	35.000	55.000
REB 6	120 V, 50/60 Hz US	790 093 005	35.000	55.000
REB 14	Pneumatic	790 094 001	61.000	90.000
REB 14	230 V, 50/60 Hz EU	790 094 002	64.000	93.000
REB 14	120 V, 50/60 Hz US	790 094 005	64.000	93.000

Article	Version	Code		Weight of machine kg	Dispatch weight kg
REB 20	Pneumatic	790 094 010		88.000	135.000
Retrofit kit REB 14 to REB 20		790 094 015		34.000	55.000

Accessories for BRB- and REB machines

Description of the tools made by Orbitalum Tools:

Multifunctional tool MFW for working on the pipe OD:

MFW 30-V / I-4-R5

Prep radius in mm	R5
Number of cutting edges	4
Weld prep profiles	V and I
max. workable wall thickness	30 mm

Multifunctional tool MFW for working on the pipe ID:

MFW 10-ID-2-R0,8

Prep radius in mm	R0.8
Number of cutting edges	2
for working on the inner diameter	ID
max. length on the counterbore / bevel	10 mm

Tool holder WH for beveling:

WH 30-V-30°

Prep angle	30°
Weld prep profile	V
max. workable wall thickness	30 mm

Tool holder WH for facing:

WH 30-I-H27

Holder height in mm	H27
Weld prep profile	I
max. workable wall thickness	30 mm

Tool holder WH for counterboring ID:

WH 10-ID-14°

Counterbore angle	14°
for working on the inner diameter	ID
max. length on the counterbore / bevel	10 mm

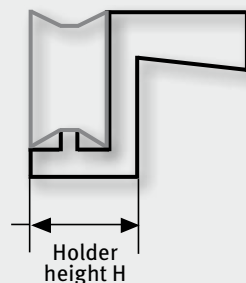

The different weld prep profiles:



Facing
I-prep



Plain beveling
V-prep



Beveling, facing
Y-prep



J-prepping
U-prep



Counterboring
ID-prep

Tool holder WH

With Torx screw. Combination possibilities of tool holder and multifunctional tools, see page 68.

Article	Weld prep profile	Applicable with	Height [mm]	Height [inch]	Code	kg
WH5-I	I	BRB 2 / REB	10	0.394	790 085 230	0.005
WH4-I*	I	BRB 2	10	0.394	790 085 234	0.033
WH12-I	I	BRB 4	20	0.787	790 086 210	0.035
WH15-I	I	BRB 4 / REB	20	0.787	790 092 202	0.100
WH15-I	I	BRB 4 / REB	27	1.063	790 092 204	0.100
WH15-I**	I	BRB 4 / REB	16.5 - 23	0.650 - 0.906	790 093 410	0.247
WH30-I	I	REB	20	0.787	790 093 202	0.166
WH30-I	I	REB	27	1.063	790 093 204	0.235
WH5-V-30°	V/Y	BRB 2	-	-	790 085 236	0.015
WH12-V-30°	V/Y	BRB 4	-	-	790 086 214	0.040
WH12-V-37,5°	V/Y	BRB 4	-	-	790 086 216	0.115
WH12-V-45°	V/Y	BRB 4	-	-	790 086 474	0.054
WH12-V-80°	V/Y	BRB 4 / REB	-	-	790 093 462	0.048
WH12-V-35°	V/Y	BRB 4	-	-	790 086 272	0.100
WH15-V-30°	V/Y	BRB 4 / REB	-	-	790 092 210	0.100
WH15-V-37,5°	V/Y	BRB 4 / REB	-	-	790 092 216	0.100
WH15-V-45°	V/Y	BRB 4 / REB	-	-	790 092 218	0.144
WH15-V-60°	V/Y	BRB 4 / REB	-	-	790 092 212	0.100
WH30-V-15°	V/Y	REB	-	-	790 093 468	0.200
WH30-V-25°	V/Y	REB	-	-	790 093 476	0.206
WH30-V-30°	V/Y	REB	-	-	790 093 210	0.192
WH30-V-32,5°	V/Y	REB	-	-	790 093 424	0.234
WH30-V-37,5°	V/Y	REB	-	-	790 093 216	0.199
WH30-V-40°	V/Y	REB	-	-	790 093 510	0.237
WH30-V-45°	V/Y	REB	-	-	790 093 404	0.204
WH5-U-20°	U	BRB 2	-	-	790 085 228	0.014
WH12-U-10°	U	BRB 4	-	-	790 086 208	0.044
WH12-U-15°	U	BRB 4 / REB	-	-	790 086 213	0.044
WH12-U-20°	U	BRB 4	-	-	790 086 224	0.047
WH12-U-20° / large clamping surface	U	BRB 4 / REB	-	-	790 086 476	0.091
WH12-U-25°	U	BRB 4	-	-	790 086 212	0.051
WH30-U-5°	U	REB	-	-	790 093 509	0.210
WH30-U-7°	U	BRB 4 / REB	-	-	790 093 408	0.206
WH30-U-10°	U	BRB 4 / REB	-	-	790 093 220	0.174
WH30-U-14°	U	REB	-	-	790 093 474	0.174
WH30-U-20°	U	BRB 4 / REB	-	-	790 093 218	0.184
WH30-U-25°	U	REB	-	-	790 093 478	0.165
WH5-ID-14° / 10 mm (0.394") deep	ID	BRB 2	-	-	790 085 232	0.017
WH5-ID-14°	ID	BRB 4 / REB	-	-	790 093 406	0.139
WH5-ID-45°	ID	BRB 4	-	-	790 086 218	0.160
WH10-ID-5° / short	ID	BRB 4 / REB	-	-	790 093 398	0.135
WH10-ID-5° / long	ID	BRB 4 / REB	-	-	790 093 400	0.152
WH10-ID-14°	ID	BRB 4 / REB	-	-	790 093 402	0.170
WH10-ID-14° / 30 mm (1.181") deep	ID	BRB 4 / REB	-	-	790 093 466	0.155
WH12-ID-10° / from ID 50 (1.969")	ID	BRB 4 / REB	-	-	790 086 280	0.060
WH10-ID-30°	ID	BRB 4 / REB	-	-	790 093 493	0.042
WH10-ID-45°	ID	REB	-	-	790 093 494	0.107
WH10-ID-80°***	ID	BRB 2 / BRB 4	-	-	790 086 275	0.075
WH5-ID-45°***	ID	BRB 2 / BRB 4 / REB	-	-	790 086 218	0.155



WH12-I



WH15-I**



WH15-V-30°



WH12-U-15°



WH5-ID-14°

* Special tool holder for facing pipes in pipe plates.

** Adjustable tool holder WH for I-prep. Comes with adjustable tool holder, multifunctional tool MFW15-V/I-4 (Code 790 093 037), Torx screws and adjusting plates.

*** Special tool holder WH for cutting tubes from tube sheets.

Multifunctional tool MFW "Economy"

Two- or four-sided tool bits without coating.

For low-alloy steel, carbon steel, aluminum and cast iron pipes.

Article	Version	For wall thickness		Applicable with tool holder / for weld prep profile	Applicable with	Code		kg
		[mm]	[inch]					
MFW15-V/I-4	Economy	2 - 15	0.079 - 0.591	V, Y, I	BRB 4 / REB	790 093 047		0.033
MFW30-V/I-4	Economy	2 - 30	0.079 - 1.181	V, Y, I	REB	790 093 043		0.055

Multifunctional tool MFW "High-Performance"

Two- and/or four-sided tool bits with high-performance protective coating against tool wear.

For high-alloy steel (stainless steel) low-alloy steel, carbon steel, aluminum and cast iron pipes.

Article	Version	For wall thickness		Applicable with tool holder / for weld prep profile	Applicable with	Code		kg
		[mm]	[inch]					
MFW5-V / I-2	High-Performance	max. 6	max. 0.236	WH5-I and WH5-U-20°	BRB 2	790 085 030		0.155
MFW30-V / I-4	High-Performance	2 - 30	0.079 - 1.181	V, Y, I	REB	790 093 033		0.055
MFW30-U-4-R5	High-Performance	2 - 30	0.079 - 1.181	I-, V-, Y-, U radius 5 mm	REB	790 093 034		0.055
MFW30-U-4-R2	High-Performance	2 - 30	0.079 - 1.181	I-, V-, Y-, U radius 2 mm	REB	790 093 035		0.060
MFW30-U-4-R1	High-Performance	2 - 30	0.079 - 1.181	I-, V-, Y-, U radius 1 mm	REB	790 093 036		0.060
MFW30-U-4-R0.4	High-Performance	2 - 30	0.079 - 1.181	I-, V-, Y-, U radius 0,4 mm	REB	790 093 042		0.060
MFW4-I-2	High-Performance	max. 4	max. 0.157	WH4-I-2 (special holder)	BRB 2	790 085 031		0.002
MFW15-V / I-4	High-Performance	2 - 15	0.079 - 0.591	V, Y, I	BRB 4 / REB	790 093 037		0.055
MFW12-V / I-2	High-Performance	2 - 12	0.079 - 0.472	V, Y, I, U radius 1.2	BRB 4	790 086 060		0.025
MFW12-U-2-R2	High-Performance	2 - 12	0.079 - 0.472	V, Y, I, U radius 2.0	BRB 4	790 086 064		0.025
MFW5-ID-2-R0.4 (14°)	High-Performance	-	-	WH5-ID-14° radius 0.4	BRB 4 / REB	790 093 039		0.003
MFW5-ID-2-R0.4 (45°)	High-Performance	-	-	WH5-ID-45° radius 0.4	BRB 4 / REB	790 086 061		0.002
MFW10-ID-2-R0.4 (80°)	High-Performance	-	-	WH10-ID-80° radius 0.4	BRB 4	790 086 062		0.002
MFW10-ID-2-R0.8 (14°)	High-Performance	-	-	WH10-ID-14° radius 0.8 mm	REB	790 093 038		0.002
MFW10-ID-2-R3.0 (14°)	High-Performance	-	-	WH10-ID-14° radius 3.0 mm	REB	790 093 041		0.004



MFW15-V/I-4 "Economy"



MFW30-U-4-R1



MFW15-V/I-4



MFW5-ID-2-R0.4 (14°)



Mobile air unit DWE 10



Air hose with quick coupling



Cutting lubrication KSS-TOP



Elbow clamping system

Mobile air unit DWE 10

Lubricator and air filter adjustable pressure range 0 - 10 bar.

Flow max. 2.6 m³/min (91.8 cfm). Air inlet side: 1/2" clutch coupling (DIN 3481).

Air outlet side: 1/2" quick coupling. Suitable for air hose 790 093 061.

Article	Code	kg
Mobile air unit DWE 10	790 093 060	4.200

Air hose with quick coupling

To connect the REB or BRB machine with the mobile air unit DWE 10.

Length: 4 m (157.5 inch). ID: 19.1 mm (0.752 inch). Air inlet side: 1/2" quick coupling.

Air outlet side: 90° angle screw with 1/2" quick coupling and a nipple to screw into the speed regulation handle on REB or BRB.

Article	Code	kg
Air hose with quick coupling	790 093 061	2.000

Cutting lubrication KSS-TOP

The water soluble, fully synthetic cooling fluid extends the tool life of the tool bits.

Contains no hazardous substances (no labeling requirements according to GefStoffV1) and is well corrosion resistant. Developed conforming to drinking water requirements according to DVGW work sheet W521 (thread cutting compounds for drinking water installations) and basically complies with these specifications. Is biologically degradable (OECD 302 B).

Article	Version	Code	kg
Cutting lubrication KSS-TOP	Pump sprayer with 500 ml	790 060 226	0.630
Cutting lubrication KSS-TOP refill canister	Canister with 10 l	790 060 227	11.000

Elbow clamping system

For preparing elbows with the REB 6 with an ID of 75 - 157 mm (2.95 - 6.18 inch).

Comes with:

- 1 Durable storage and shipping case
- 1 Mandrel with clamping mechanism for elbows
- 1 Straightening tool
- 8 Sets with 3 pins for dimension range 75 - 157 mm (2.95 - 6.18 inch).

Article	Code	kg
Elbow clamping system for REB 6 complete	790 093 015	9.900

Optional clamping wedges

To extend the dimension of the REB standard machines.

Article	Applicable with	Pipe ID [mm]	Pipe ID [inch]	Code	kg
Clamping wedges	REB 6	155 - 166	6.102 - 6.535	790 093 295	1.300
Clamping wedges	REB 14	320 - 339	12.598 - 13.346	790 094 189	3.600
Clamping wedges	REB 14	331 - 350	13.031 - 13.780	790 094 190	3.850



Clamping wedges optional

Plastic (POM) clamping shell segments

Customized plastic (POM) clamping shell segments for REB 6, REB 14 and REB 20 for thin-walled pipes. Deformation-free clamping system.

These clamping shell segments are especially manufactured for an individual ID of a pipe and can be utilized only for this diameter. Please specify the exact pipe ID with your order.

Comes with:

- 6 Cylinder head screws
- 3 Clamping shells
- 3 Plastic (POM) clamping shell segments

Other dimensions on request.

Article	Applicable with	Pipe ID [mm]	Pipe ID [inch]	Code	kg
Plastic clamping shell segment	REB 6	108.2 - 110.1	4.260 - 4.335	790 093 297	1.600
Plastic clamping shell segment	REB 6	147.0 - 149.0	5.787 - 5.866	790 093 298	1.905
Plastic clamping shell segment	REB 14	160.0	6.299	790 094 203	3.700
Plastic clamping shell segment	REB 14	161.5 - 162.7	6.358 - 6.406	790 094 202	3.800
Plastic clamping shell segment	REB 14	211.6 - 213.5	8.331 - 8.401	790 094 206	5.600
Plastic clamping shell segment	REB 14	227.58	8.960	790 094 198	5.880
Plastic clamping shell segment	REB 14	250.0	9.843	790 094 208	5.600
Plastic clamping shell segment	REB 14	264.7 - 266.2	10.421 - 10.480	790 094 210	5.600
Plastic clamping shell segment	REB 14	314.7 - 315.9	12.390 - 12.437	790 094 222	4.100
Plastic clamping shell segment	REB 14	342.9	13.500	790 094 226	4.800
Plastic clamping shell segment	REB 14	347.7	13.689	790 094 224	4.750



Plastic (POM) clamping shell segments



ID-Tracking

ID tracking for REB 14 and REB 20

The REB ID tracking can be used to prepare thin-walled, large-scale pipes for welding, where precise pipe end preparation and an exact base height are required.

The module measures the pipe ID. The force of the spring on the inside diameter ensures that the roller “tracks” any irregularities of the pipe, producing a weld prep exactly in accordance with the ID. Thus maintaining a perfect weld prep. All weld preparations such as V-, Y- and U-preps can be realized with the ID tracking module.

Comes with:

- ID tracking module
- Mount for plane
- Assembly instructions

Application range	ID Tracking for REB 14		ID Tracking for REB 20	
	[mm]	[inch]	[mm]	[inch]
Pipe ID	150 - 320	5.910 - 12.600	290 - 500	11.417 - 19.685
Wall thickness max.	15	0.591	10	0.394

Article	Code	kg
ID-Tracking for REB 14, REB 20	790 094 013	5.750

Combination possibilities of tool holder WH and multifunctional tools MFW for REB and BRB machines

Code-No.	Tool holder	Torx screw	Suitable multifunctional tools
Tools for "I-prep"			
790 085 234	WH 4-I	790 085 244	790 085 031 with R 0
790 085 230	WH 5-I	790 093 224	790 085 030 with R 0.4
790 086 210	WH 12-I-H 20 mm	790 086 220	790 086 060 with R 1.2
790 092 202	WH 15-I-H 20 mm	790 093 226	790 093 037 with R 0
790 092 204	WH 15-I-H 27 mm	790 093 226	790 093 037 with R 0
790 093 202	WH 30-I-H 20 mm	790 093 226	790 093 033 with R 0
790 093 204	WH 30-I-H 27 mm	790 093 226	790 093 033 with R 0
790 093 410	WH 15-I-H 16.5-23 mm (adjustable)	790 093 226 / 790 093 425	790 093 037 with R 0
Tools for "V-prep" and "Y-prep"			
790 085 236	WH 5-V-30°	790 093 224	790 085 030 with R 0.4
790 086 214	WH 12-V-30°	790 086 220	790 086 060 with R 1.2
790 086 272	WH 12-V-35°	790 086 220	790 086 060 with R 1.2
790 086 216	WH 12-V-37.5°	790 086 220	790 086 060 with R 1.2
790 086 474	WH 12-V-45°	790 086 022	790 086 060 with R 1.2
790 093 462	WH 12-V-80°	790 086 220	790 086 060 with R 1.2
790 092 210	WH 15-V-30°	790 093 226	790 093 037 with R 0 / 790 093 047
790 092 216	WH 15-V-37.5°	790 093 226	790 093 037 with R 0 / 790 093 047
790 092 218	WH 15-V-45°	790 093 226	790 093 037 with R 0 / 790 093 047
790 092 212	WH 15-V-60°	790 093 226	790 093 037 with R 0 / 790 093 047
790 093 468	WH 30-V-15°	790 093 226	790 093 033 with R 0 / 790 093 043
790 093 476	WH 30-V/U-25°	790 093 226	790 093 033 with R 0 / 790 093 043
790 093 210	WH 30-V-30°	790 093 226	790 093 033 with R 0 / 790 093 043
790 093 424	WH 30-V-32.5°	790 093 226	790 093 033 with R 0 / 790 093 043
790 093 216	WH 30-V-37.5°	790 093 226	790 093 033 with R 0 / 790 093 043
790 093 404	WH 30-V-45°	790 093 226	790 093 033 with R 0 / 790 093 043
790 093 470	WH 30-V-50°	790 093 226	790 093 033 with R 0 / 790 093 043
790 093 472	WH 30-V-55°	790 093 226	790 093 033 with R 0 / 790 093 043
Tools for "U-prep"			
790 085 228	WH 5-U-20°	790 093 224	790 085 030 with R 0.4
790 086 208	WH 12-U-10°	790 086 220	790 086 060 with R 1.2 / 790 086 064 with R 2
790 086 213	WH 12-U-15°	790 086 220	790 086 060 with R 1.2 / 790 086 064 with R 2
790 086 224	WH 12-U-20°	790 086 220	790 086 060 with R 1.2 / 790 086 064 with R 2
790 086 476	WH 12-U-20° large clamping surface	790 086 220	790 086 060 with R 1.2 / 790 086 064 with R 2
790 086 212	WH 12-U-25°	790 086 220	790 086 060 with R 1.2 / 790 086 064 with R 2
790 093 408	WH 30-U-7°	790 093 226	790 093 034 with R 5 / 790 093 035 with R 2 / 790 093 036 with R 1
790 093 220	WH 30-U-10°	790 093 226	790 093 034 with R 5 / 790 093 035 with R 2
790 093 474	WH 30-U-14°	790 093 226	790 093 034 with R 5 / 790 093 035 with R 2
790 093 468	WH 30-V/U-15°	790 093 226	790 093 034 with R 5 / 790 093 035 with R 2
790 093 218	WH 30-U-20°	790 093 226	790 093 034 with R 5 / 790 093 035 with R 2
790 093 478	WH 30-U-25°	790 093 226	790 093 034 with R 5 / 790 093 035 with R 2
Tools for "beveling / counterboring"			
790 085 232	WH 5-ID-14°	790 093 224	790 093 039 with R 0.4
790 093 406	WH 5-ID-14°	790 093 224	790 093 039 with R 0.4
790 086 218	WH 5-ID-45°	790 093 224	790 086 061 with R 0.4
790 093 398	WH 10-ID-5° / short	790 093 225	790 093 038 with R 0.8 / 790 093 041 with R 3
790 093 400	WH 10-ID-5° / long	790 093 225	790 093 038 with R 0.8 / 790 093 041 with R 3
790 093 402	WH 10-ID-14°	790 093 225	790 093 038 with R 0.8 / 790 093 041 with R 3
790 093 466	WH 10-ID-14° / 30 mm deep	790 093 225	790 093 038 with R 0.8 / 790 093 041 with R 3
790 086 296	WH 10-ID-60°	790 093 224	790 093 038 with R 0.8 / 790 093 041 with R 3
790 086 275	WH 10-ID-80°	790 086 220	790 086 062 with R 0.4
790 086 280	WH 12-ID-10° from ID 50	790 086 217	790 086 060 with R 1.2
790 093 494	WH 10-ID-45°	790 086 220	790 093 040 with R 0.8
790 093 493	WH 10-ID-30°	790 086 220	790 093 040 with R 0.8

Application range of tool holder for J-prep

		BRB 2 Mandrel Ø 12,7 WZT-Ø 51		BRB 2 Mandrel Ø 19 WZT-Ø 51		BRB 4 Mandrel Ø 19 WZT-Ø 68		BRB 4 Mandrel Ø 32 WZT-Ø 68		BRB 4 Mandrel Ø 32 WZT-Ø 90		BRB 4 Mandrel Ø 32 WZT-Ø 120		REB 6 Mandrel Ø 40 WZT-Ø 183		REB 14 Mandrel Ø 63 WZT-Ø 375	
		Max. ID with a height of land 1 mm (0.039 inch)															
Code-No.	Description	ID max. [mm] [inch]	ID min. [mm] [inch]	ID max. [mm] [inch]	ID min. [mm] [inch]	ID max. [mm] [inch]	ID min. [mm] [inch]	ID max. [mm] [inch]	ID min. [mm] [inch]	ID max. [mm] [inch]	ID min. [mm] [inch]	ID max. [mm] [inch]	ID min. [mm] [inch]	ID max. [mm] [inch]	ID min. [mm] [inch]	ID max. [mm] [inch]	ID min. [mm] [inch]
790 085 228	WH 5-U-20°	34 1.339	15 0.591	38 1.496	21 0.827	-	-	-	-	-	-	104 4.094	34 1.339	159 6.260	49 1.929	320 12.598	65 2.559
790 093 220	WH 30-U-10°	-	-	-	-	-	-	-	-	-	-	58 2.283	34 1.339	121 4.764	49 1.929	313 12.323	65 2.559
790 093 474	WH 30-U-14°	-	-	-	-	-	-	-	-	-	-	58 2.283	34 1.339	121 4.764	49 1.929	313 12.323	65 2.559
790 093 468	WH 30-V/U-15°	-	-	-	-	-	-	-	-	-	-	58 2.283	34 1.339	121 4.764	49 1.929	313 12.323	65 2.559
790 093 218	WH 30-U-20°	-	-	-	-	-	-	-	-	-	-	58 2.283	34 1.339	121 4.764	49 1.929	313 12.323	65 2.559
790 093 478	WH 30-U-25°	-	-	-	-	-	-	-	-	-	-	58 2.283	34 1.339	121 4.764	49 1.929	313 12.323	65 2.559
790 093 408	WH 30-U-7°	-	-	-	-	-	-	-	-	-	-	58 2.283	34 1.339	121 4.764	49 1.929	313 12.323	65 2.559
790 086 208	WH 12-U-10°	-	-	-	-	32 1.260	21 0.827	-	-	54 2.126	34 1.339	84 3.307	34 1.339	147 5.787	49 1.929	320 12.598	65 2.559
790 086 224	WH 12-U-20°	-	-	-	-	32 1.260	21 0.827	-	-	54 2.126	34 1.339	84 3.307	34 1.339	147 5.787	49 1.929	320 12.598	65 2.559
790 086 212	WH 12-U-25°	-	-	-	-	32 1.260	21 0.827	-	-	54 2.126	34 1.339	84 3.307	34 1.339	147 5.787	49 1.929	320 12.598	65 2.559

Application range of tool holders for counterboring

		BRB 2 Mandrel Ø 12.7 WZT-Ø 51		BRB 2 Mandrel Ø 19 WZT-Ø 51		BRB 4 Mandrel Ø 19 WZT-Ø 68		BRB 4 Mandrel Ø 32 WZT-Ø 68		BRB 4 Mandrel Ø 32 WZT-Ø 90		BRB 4 Mandrel Ø 32 WZT-Ø 120		REB 6 Mandrel Ø 40 WZT-Ø 183		REB 14 Mandrel Ø 63 WZT-Ø 375	
		Workable pipe inner diameter (0.5 mm / 0.020 inch safe distance to mandrel)															
Code-No.	Description	ID max. [mm] [inch]	ID min. [mm] [inch]	ID max. [mm] [inch]	ID min. [mm] [inch]	ID max. [mm] [inch]	ID min. [mm] [inch]	ID max. [mm] [inch]	ID min. [mm] [inch]	ID max. [mm] [inch]	ID min. [mm] [inch]	ID max. [mm] [inch]	ID min. [mm] [inch]	ID max. [mm] [inch]	ID min. [mm] [inch]	ID max. [mm] [inch]	ID min. [mm] [inch]
790 085 232	WH 5-ID-14° / 10 mm deep	38 1.496	27 1.063	38 1.496	36 1.417	55 2.165	36 1.417	55 2.165	42 1.654	77 3.031	42 1.654	107 4.213	42 1.654	159 6.260	53 2.087	320 12.598	92 3.622
790 093 398	WH 10-ID-5° / short	-	-	-	-	-	-	-	-	72 2.835	59 2.323	105 4.134	61 2.402	159 6.260	71 2.795	320 12.598	95 3.740
790 093 400	WH 10-ID-5° / long	-	-	-	-	-	-	-	-	72 2.835	59 2.323	105 4.134	61 2.402	159 6.260	71 2.795	320 12.598	95 3.740
790 093 402	WH 10-ID-14°	-	-	-	-	-	-	-	-	72 2.835	59 2.323	105 4.134	61 2.402	159 6.260	71 2.795	320 12.598	95 3.740
790 093 406	WH 5-ID-14°	-	-	-	-	-	-	-	-	60 2.362	39 1.535	96 3.780	43 1.693	159 6.260	60 2.362	320 12.598	92 3.622
790 093 466	WH 10-ID-14° / 30 mm deep	-	-	-	-	-	-	-	-	61 2.402	53 2.087	105 4.134	61 2.402	159 6.260	78 3.071	320 12.598	101 3.976
790 086 218	WH 5-ID-45°	24 0.945	20* 0.787	37 1.457	24 0.945	49 1.929	27 1.063	49 1.929	37 1.457	40 1.575	40 1.575	107 4.213	37 1.457	159 6.260	58 2.283	320 12.598	92 3.622
Application range of tool holders for facing																	
790 086 275	WH 10-ID-80°	41 1.614	37 1.457	41 1.614	43 1.693	58 2.283	43 1.693	58 2.283	56 2.205	80 3.150	56 2.205	110 4.331	56 2.205	159 6.260	64 2.520	320 12.598	92 3.622

* With diameter 20 mm: max. length of bevel 4 - 5 mm (0.157 - 0.197 inch).

Abbreviations:
WH = Tool holder
WZT = Tool support / Tool retainer

70

Pipe Beveling Technology

Length of land with the use of tool holder for facing 790 092 202 / 790 093 202 and 790 086 210

Code-No.	Description (α)	MFW 12-V/I-2-R1.2 790 086 060	MFW 30-U-4-R2 790 093 035	MFW 30-U-4-R5 790 093 034
		Length of land (X1)		
790 085 228	WH 5-U-20°	-	-	-
790 093 218	WH 30-U-20°	-	1.4 mm / 0.055 inch	0 mm / 0 inch
790 093 220	WH 30-U-10°	-	2.5 mm / 0.098 inch	0.5 mm / 0.020 inch
790 093 408	WH 30-U-7°	-	3.8 mm / 0.150 inch	1.1 mm / 0.043 inch
790 093 474	WH 30-U-14°	-	2.3 mm / 0.091 inch	0 mm / 0 inch
790 093 478	WH 30-U-25°	-	1.1 mm / 0.043 inch	0 mm / 0 inch
790 086 208	WH 12-U-10°	1.5 mm / 0.059 inch	-	-
790 086 212	WH 12-U-25°	1.5 mm / 0.059 inch	-	-
790 086 224	WH 12-U-20°	1.5 mm / 0.059 inch	-	-

Length of land with the use of tool holder for facing 790 093 410 (adjustable)

Code-No.	Description (α)	MFW 12-V/I-2-R1.2 790 086 060	MFW 30-U-4-R2 790 093 035	MFW 30-U-4-R5 790 093 034
		Length of land (X1)		
790 093 408	WH 30-U-7°	-	1 - 7 mm / 0.039 - 0.276 inch	0 - 2.5 mm / 0 - 0.098 inch
790 093 220	WH 30-U-10°	-	0 - 6 mm / 0 - 0.236 inch	0 - 3 mm / 0 - 0.118 inch
790 093 474	WH 30-U-14°	-	0 - 6.5 mm / 0 - 0.256 inch	0 - 1 mm / 0 - 0.039 inch
790 093 218	WH 30-U-20°	-	0 - 5 mm / 0 - 0.197 inch	0 - 3.5 mm / 0 - 0.138 inch
790 093 478	WH 30-U-25°	-	0 - 5 mm / 0 - 0.197 inch	0 - 1 mm / 0 - 0.039 inch
790 086 208	WH 12-U-10°	0 - 5 mm / 0 - 0.197 inch	-	-
790 086 224	WH 12-U-20°	0 - 5 mm / 0 - 0.197 inch	-	-
790 086 212	WH 12-U-25°	0 - 5 mm / 0 - 0.197 inch	-	-

Abbreviations:
WH = Tool holder
MFW = Multifunctional tool

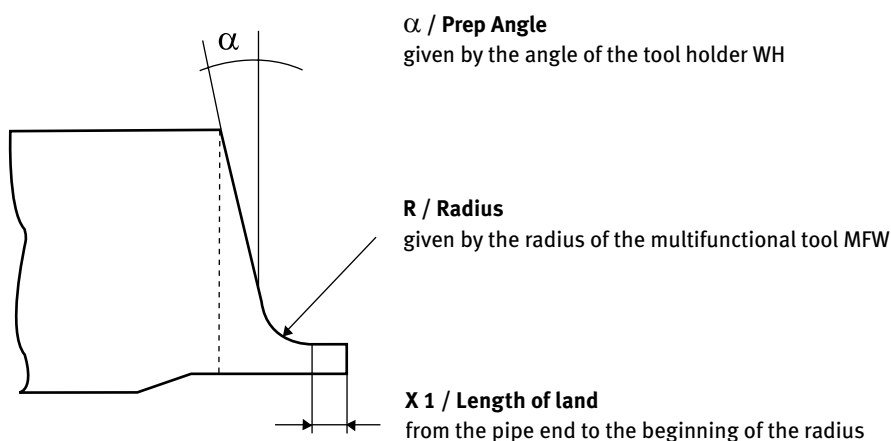



One machine – complete electrode preparation!



Grinding electrodes:
4 different angles and
6 different electrode sizes



Facing electrodes



Cutting electrodes



Durable storage and
shipping case



Exchangeable diamond
grinding wheels for
optimal performance

72

Tungsten Grinder ESG Plus

Tungsten Grinder

- Repeatable points every time due to preset grinding angles
- Easy and fast to use
- Optimum preparation for orbital and manual welding
- Longitudinal grinding for optimum arc ignition and excellent arc stability
- Guarantees longer tool life and ease of ignition of the tungsten electrode
- Specially designed for one-off jobs on site
- Compact design, optimum resilience and perfect reproducibility
- Solid, functional design
- Precise orbital grinding
- Grinding angles 15° / 18° / 22,5° / 30° or 15° / 30° / 45° / 60°
- Facility for easy trimming of the electrodes (optional)
- External dust extractor can be easily adapted
- Short preparation times with high grinding performance
- No adjustment needs to be done before operation

ESG Plus, ESG Plus²

This ESG Plus is the perfect hand-held grinder for cutting, grinding and planing electrodes which are used in WIG/TIG welding machines. Consider country-specific regulations, standards and guidelines when using tungsten electrodes with thorium.

ESG Plus²: The first portable tungsten grinder with two different grinding wheels. This allows the electrode to be pre-ground with the coarse diamond wheel then finished with the fine diamond wheel.

Machine comes with:

- 1 Tungsten Grinder ESG Plus or ESG Plus²
- 1 Durable storage and shipping case
- ESG Plus: 1 Diamond grinding wheel (medium, Code 790 052 488)
ESG Plus²: 1 Diamond grinding wheel (coarse, Code 790 052 550) and 1 diamond grinding wheel (fine, Code 790 052 487)
- 1 Tool to replace the grinding wheel
- 1 Set of operating instructions and spare parts list



ESG Plus



ESG Plus²

Application range	ESG Plus, ESG Plus ²
Electrode Ø	1.0 / 1.6 / 2.0 / 2.4 / 3.2 / 4.0 mm 0.040 / 1/16 / 0.080 / 3/32 / 1/8 / 5/32 inch
Grinding angles	15° / 18° / 22.5° / 30° or 15° / 30° / 45° / 60°
Technical data	Electric drive with single-phase AC motor
Dimensions (with drive)	Ø 65 x 350 mm / 2.56 x 13.78 inch
Power	500 W
Power-on time	100 %
Rotary speed	30,000 rpm
Main supply cable (length)	3 m / 118.1 inch
Vibration level in accordance with 28662, part 1	< 2.5 m/s ²
Noise level at the workplace	Idle running approx. 83 dB (A)

Article	Version	Grinding angles [°]	Code	Weight of machine kg	Dispatch weight kg
ESG Plus	230 V, 50/60 Hz EU	15 / 18 / 22.5 / 30	790 052 485	1.430	3.560
ESG Plus	230 V, 50/60 Hz EU	15 / 30 / 45 / 60	790 052 545	1.430	3.560
ESG Plus ²	230 V, 50/60 Hz EU	15 / 18 / 22.5 / 30	790 052 585	1.520	3.825
ESG Plus ²	230 V, 50/60 Hz EU	15 / 30 / 45 / 60	790 052 546	1.520	3.825
ESG Plus	110 V, 50/60 Hz EU/US	15 / 18 / 22.5 / 30	790 052 486	1.560	3.570
ESG Plus	110 V, 50/60 Hz EU/US	15 / 30 / 45 / 60	790 052 645	1.560	3.570
ESG Plus ²	110 V, 50/60 Hz EU/US	15 / 18 / 22.5 / 30	790 052 586	1.520	3.825
ESG Plus ²	110 V, 50/60 Hz EU/US	15 / 30 / 45 / 60	790 052 646	1.520	3.825

Tungsten Grinding Technology

Accessories for ESG Plus



Diamond grinding wheels

Diamond grinding wheels

Replaceable grinding wheel diamond-coated on both sides for optimal performance.

For 1.0 and 1.6 mm (0.039 and 0.063 inch) electrodes we recommend the standard grinding wheel. For 2.0 and 2.4 mm (0.078 and 0.094 inch) electrodes a medium grained grinding wheel and for 3.2 and 4.0 mm (0.126 and 0.157 inch) a coarse grained grinding wheel is advisable.

Article	Version	Grinding wheel Ø [mm/inch]	s [mm/inch]	Code	kg
Diamond grinding wheel*	Standard	32.0/1.260	1.2/0.047	790 052 460	0.005
Diamond grinding wheel**	Fine	33.5/1.319	2.2/0.087	790 052 487	0.010
Diamond grinding wheel**	Medium	33.5/1.319	2.2/0.087	790 052 488	0.011
Diamond grinding wheel**	Coarse	33.5/1.319	2.2/0.087	790 052 550	0.011

* for ESG 4

** for ESG Plus



Cutting device

Cutting device

To cut tungsten electrodes to length.

Application range	[mm]	[inch]
Electrode Ø	1.0 / 1.6 / 2.0 / 2.4	0.040 / 1/16 / 0.080 / 3/32
Fixed cutting lengths*	12 / 13 / 15 / 17	0.472 / 0.512 / 0.591 / 0.669

* Other cutting lengths possible.

Article	Code	kg
Cutting device for ESG Plus	790 052 513	0.030



Electrode holder

Electrode holder

With clamping collet (Code 790 052 481) for clamping range 1.0 - 3.2 mm (0.039 - 0.126 inch).

Article	Code	kg
Electrode holder	790 052 457	0.023



Clamping collet

Clamping collet

To center the electrode in the holder.

For easy grinding of smaller electrodes.

Flexible clamping collet for clamping range 1.0 - 3.2 mm (0.039 - 0.126 inch).

Article	Clamping range [mm]	Clamping range [inch]	Code	kg
Clamping collet	1.0 - 3.2	0.039 - 0.126	790 052 481	0.002

Wall-/table-/vice-mounting plate

For stationary ESG Plus set-up.

Article	Code	kg
Wall-/table-/vice-mounting plate	790 052 483	0.102



Wall-/table-/vice-mounting plate

Protective cover

Easy to adapt on the ESG Plus head.

With integrated retainer for suction units. For use on electrodes with thorium.
Consider country-specific regulations, standards and guidelines.

Article	Code	kg
Protective cover for ESG Plus	790 052 496	0.220
Protective cover for ESG Plus ²	790 052 596	0.220

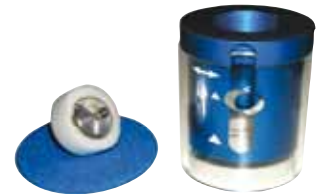

Protective cover

Double-Decker Kit

Easy to mount to the ESG Plus. This attachment makes it possible to use 2 different grinding wheels at the same time. The kit contains a head and a diamond grinding wheel (Code 790 052 550) with an extension shaft.

Article	Grinding angles [°]	Code	kg
Double-Decker Kit	15 / 18 / 22.5 / 30	790 052 490	0.160
Double-Decker Kit	15 / 30 / 45 / 60	790 052 390	0.160



Double-Decker Kit



76

Threading, Jointing and Sealing Technology

Accessories for Pipe Threading Technology

Automatic quick-change die-heads ASK

for Whitworth pipe threads according to DIN 2999

For threaded pipes according to DIN 2440 and 2441 as well as for stainless steel pipes.
For KM 2. Die-heads are equipped with threading chasers made of HSS (high-speed steel). In the factory the die-heads are precision-adjusted to the requirements according to the thread standards. Right-handed.

Die-heads ASK are also applicable for:

- up to R 2 on KM 2 and GTM 2
- up to R 1 1/4 on TGA



Automatic quick-change die-head ASK

Article	Version	Code	kg
Automatic quick-change die-head ASK	R 3/8	790 003 403	2.200
Automatic quick-change die-head ASK	R 1/2	790 003 404	2.380
Automatic quick-change die-head ASK	R 3/4	790 003 405	2.400
Automatic quick-change die-head ASK	R 1	790 003 406	2.950
Automatic quick-change die-head ASK	R 1 1/4	790 003 407	2.870
Automatic quick-change die-head ASK	R 1 1/2*	790 003 408	3.165
Automatic quick-change die-head ASK	R 2*	790 003 409	4.055

* not for TGA

Replacement sets of threading chasers

for Whitworth pipe threads according to DIN 2999

Made of HSS (high-speed steel). Right-handed.



Replacement set of threading chasers for ASK

Article	Version	Code	kg
Replacement set of threading chasers for ASK	R 1/4	790 003 502	0.110
Replacement set of threading chasers for ASK	R 3/8	790 003 503	0.100
Replacement set of threading chasers for ASK	R 1/2	790 003 504	0.145
Replacement set of threading chasers for ASK	R 3/4	790 003 505	0.130
Replacement set of threading chasers for ASK	R 1	790 003 506	0.170
Replacement set of threading chasers for ASK	R 1 1/4	790 003 507	0.145
Replacement set of threading chasers for ASK	R 1 1/2*	790 003 508	0.205
Replacement set of threading chasers for ASK	R 2*	790 003 509	0.260

* not for TGA

Replacement sets of threading chasers

for pipe threads according to DIN 2440 and 2441

Made of HSS (high-speed steel). Right-handed.



Replacement set of threading chasers for ASK

Article	Version	Code	kg
Replacement set of threading chasers	G 1	790 005 310	0.175
Replacement set of threading chasers	G 1 1/4	790 005 311	0.145
Replacement set of threading chasers	G 1 1/2*	790 005 312	0.200
Replacement set of threading chasers	G 2*	790 005 313	0.200

* not for TGA



Nipple holder

Nipple holder

With internal clamping. Self-clamping. For pipes according to DIN 2440.

Article	Version	Thread	Code	kg
Nipple holder	DN 15	R 1/2	790 002 101	0.345
Nipple holder	DN 20	R 3/4	790 002 102	0.566
Nipple holder	DN 25	R 1	790 002 103	0.740
Nipple holder	DN 32	R 1 1/4	790 002 104	1.120
Nipple holder	DN 40*	R 1 1/2	790 002 105	1.420
Nipple holder	DN 50*	R 2	790 002 106	2.120

* not for TGA



Thread cutting compound
SPN PARALIQU® PLUS

Thread cutting compound SPN PARALIQU® PLUS

Pressure absorption capacity 4 times higher than required according to DVGW worksheet W521. Readily biodegradable. On synthetic basis for drinking-water installations and for the food industries, conforms to requirements regarding food and beverage stuff legislation set out in DVGW/ SVGW/ ÖVGW, environmentally friendly.

Article	Version	Code	kg
SPN PARALIQU® PLUS*	Canister with 10 l (352 fl oz)	790 060 202	11.100

* while stock last.



Thread cutting compound
NORMOLIC Red®

Thread cutting compound NORMOLIC Red®

Normolic Red is a DVGW-tested (German Technical and Scientific Association for Gas and Water) thread cutting compound for drinking water installations.

Coloured red. Free from mineral oils. Water-soluble. Easily rinsed out without affecting the appearance, taste and smell of the drinking water when rinsed according to DIN 1988. Dyn. viscosity: at 20 °C: > 20 mPas (ISO 3104).

Article	Version	Code	kg
NORMOLIC Red®	Canister with 10 l (352 fl oz)	790 051 263	11.500

Thread Jointing Technology

Thread jointing compound PARALIQ® PM 35

For gas, air and water up to 130 °C.

Approved by the DVGW/SVGW/ÖVGW in accordance with DIN EN 751, part 2 (DIN 30 660) in the house installation, especially for drinking-water installations. For use with flax.



Thread jointing compound PARALIQ® PM 35

Article	Version	Code	kg
Thread jointing compound PARALIQ® PM 35	Can of 600 g	790 060 102	0.690

Thread sealing tape PARALIQ® PM 35

For gas, air and water up to 130 °C.

Approved by the DVGW/SVGW/ÖVGW in accordance with DIN EN 751, part 2 (DIN 30 660) in the house installation, especially for drinking-water installations. Also applicable for sealing requirements conforming to standards for petrol, heating oil, diesel and fuel installations. Synthetic tape. For use without flax.



Thread sealing tape PARALIQ® PM 35

Article	Version	Code	kg
Thread sealing tape PARALIQ® PM 35	Roll of 25 m, 16 mm wide (82 ft, 0.630 inch wide)	790 060 112	0.050

Flax dispenser (retail pack)

Including 10 flax bobbins.

Innovative and unique retail pack for the presentable display of flax bobbins at the sales counter.



Flax dispenser (retail pack)

Article	Code	kg
Flax dispenser, retail pack of 10 bobbins	790 052 702	* 0.780
Flax dispenser, retail pack of 10 bobbins, Set incl. flax pocket dispenser	790 052 703	1.000

* Price refers to a single flax bobbin. Minimum purchase: 10 bobbins = 1 retail pack.

Flax dispenser

Empty, with fixing plate for mounting on wall or work bench.

Easy to use, no waste, optimal proportioning.



Flax dispenser

Article	Code	kg
Flax dispenser	790 052 701	0.304

Flax bobbin pocket dispenser

For the fitters pocket. Easy to use, no waste, optimal proportioning.



Flax bobbin pocket dispenser

Article	Version	Code	kg
Flax bobbin pocket dispenser	with flax bobbin	790 052 710	0.225
Flax bobbin pocket dispenser	without flax bobbin	790 052 708	0.135

Seals



Seal dispenser



Seals

Seal dispenser

For gas and water installations. Approved by the DVGW in accordance with DIN 3535, Part 6. With 225 asbestos-free seals and protective covering.

Article	Code		kg
Seal dispenser	790 052 721		0.682
Seal dispenser, empty	790 052 722		0.335
Protective covering for seal dispenser	790 052 723		0.049

Seals for seal dispenser

IT-seals, asbestos-free.

Explanations

R = Raccord (union/fittings)

RV = Radiator valve

H = Dutchman seal

HK = Dutchman seal, small

HG = Dutchman seal, large

Article	Version	Dimension	Quantity per pack	Code		kg*
Seals	R 1/4	10 x 6	100	790 052 726		0.001
Seals	R 3/8	14 x 10	100	790 052 727		0.001
Seals	R 3/8	15 x 8	100	790 052 728		0.001
Seals	R 3/8	15 x 10	100	790 052 729		0.001
Seals	R 1/2	18 x 10	100	790 052 730		0.001
Seals	R 1/2	18 x 11	100	790 052 731		0.001
Seals	R 1/2	18 x 12	100	790 052 732		0.001
Seals	R 3/4	23 x 17	100	790 052 733		0.001
Seals	R 3/4	24 x 15	100	790 052 734		0.001
Seals	R 1	30 x 22	100	790 052 735		0.001
Seals	R 1 1/4	37 x 29	100	790 052 736		0.001
Seals	R 1 1/4	39 x 32	100	790 052 737		0.001
Seals	R 1 1/2	44 x 37	100	790 052 738		0.001
Seals	R 2	56 x 48	50	790 052 739		0.002
Seals	Leather 3/4	23 x 16	100	790 052 740		0.001
Seals	RV 3/4	23 x 17	100	790 052 741		0.001
Seals	H 3/4	38 x 27	100	790 052 742		0.002
Seals	H 1	44 x 32	100	790 052 743		0.002
Seals	H 1 1/4	55 x 42	50	790 052 744		0.004
Seals	H 1 1/2	62 x 46	50	790 052 745		0.002
Seals	H 2	78 x 60	50	790 052 746		0.007
Seals	HK 3/8	24 x 17	100	790 052 747		0.001
Seals	HK 1/2	30 x 21	100	790 052 748		0.001
Seals	HG 3/8	27 x 19	100	790 052 749		0.001
Seals	HG 1/2	34 x 23	100	790 052 750		0.001

* Weight per seal

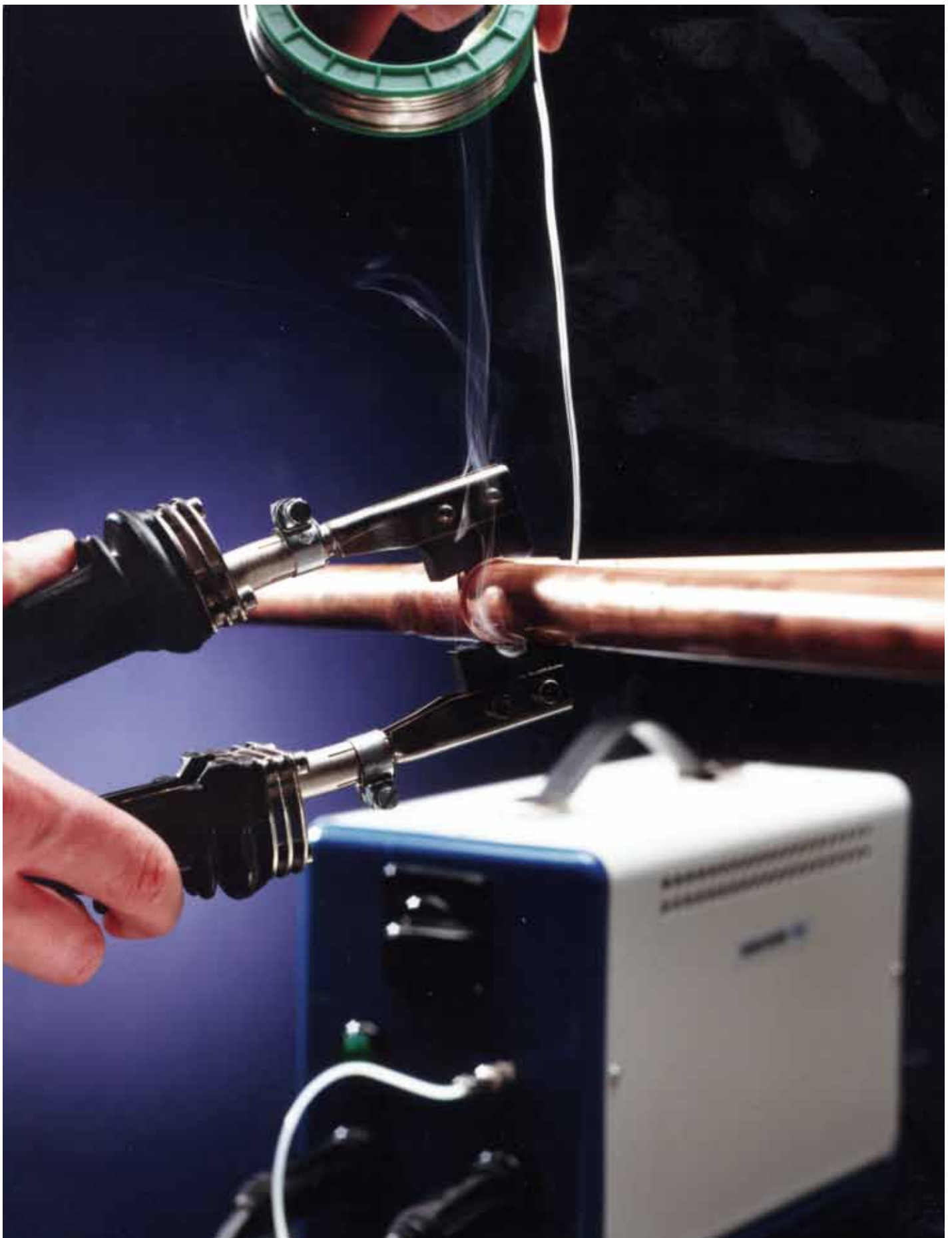

Copper Pipe Installation Technology

81

Accessories for LAM 1500, LAM 1600



Clamp holder with carbon V-electrode

Clamp holder with carbon V-electrode

Made of stainless steel.

Article	Code		kg
Clamp holder with carbon V-electrode	790 057 020		0.038



Carbon V-electrode

Carbon V-electrode

Minimum purchase: 10 pieces.

Article	Code		kg
Carbon V-electrode	790 057 025		0.010



Stick electrode

Stick electrode

Minimum purchase: 6 pieces.

Article	Code		kg
Stick electrode	790 057 026		0.020



Heating tongs with cable

Heating tongs with cable

Complete. Cable length 2.7 m (106.3 inch).
Only for LAM 1600.

Article	Code		kg
Heating tongs with cable	790 057 351		2.090

Cleaning brushes and calibrating tools

Cleaning brushes

Metal brushes to clean copper fittings on the inner diameter

Extended service life through high-grade steel alloy.



Metal brushes to clean copper fittings on the inner diameter

Article	Pipe ID [mm]	Pipe ID [inch]	Code	kg
Metal brushes to clean copper fittings on the inner diameter	12	0.472	790 072 283	0.025
Metal brushes to clean copper fittings on the inner diameter	15	0.591	790 072 285	0.022
Metal brushes to clean copper fittings on the inner diameter	18	0.709	790 072 288	0.025
Metal brushes to clean copper fittings on the inner diameter	22	0.866	790 072 289	0.027

Cleaning brushes

Ring brushes to clean copper pipes on the outer diameter

Extended service life through high-grade steel alloy.



Ring brushes to clean copper pipes on the outer diameter

Article	Pipe OD [mm]	Pipe OD [inch]	Code	kg
Ring brushes to clean copper pipes on the outer diameter	10	0.394	790 072 301	0.021
Ring brushes to clean copper pipes on the outer diameter	18	0.709	790 072 307	0.032

Calibrating tools

In order to get a capillary gap according to standard DIN 1786.



Calibrating tools

Article	Pipe OD [mm]	Pipe OD [inch]	Pipe ID [mm]	Pipe ID [inch]	Code	kg
Calibrating tools	12	0.472	10	0.394	790 072 417	0.120
Calibrating tools	15	0.591	13	0.512	790 072 421	0.175
Calibrating tools	18	0.709	16	0.630	790 072 427	0.250



Work benches, tool box, pipe vices, deburring tool

Work benches

Dimensions	Work bench, small	Work bench, large	Collapsible work bench
Dimensions (l x w x h)	120 x 75 x 85 cm	150 x 100 x 85 cm	100 x 70 x 85 cm
Article	Code		kg
Work bench, small, dismountable, with 1 tool box support	790 052 001		64.000
Work bench, large*, dismountable, with 2 tool box supports	790 052 004		95.000
Collapsible work bench, load capacity: 650 kg/1433 lbs	790 052 030		32.000

* while stock last.

Tool box

For mounting under the work benches Code 790 052 001 and 790 052 004.

Dimensions	Tool box		
Outside dimensions	100 x 40 x 65 cm / 39.37 x 15.75 x 25.59 inch		
Article	Code		kg
Tool box	790 052 101		50.000

Pipe vices

Application range	Chain pipe vice	Chain pipe vice with extension roller chain	Bench vice
Pipe OD	up to 165 mm / 6.496 inch	up to 230 mm / 9.055 inch	20 - 250 mm / 0.8 - 9.8 inch
Article	Code		kg
Chain pipe vice, complete with pipe support	790 052 201		6.200
Extension roller chain	790 052 859		0.870
Bench vice for plastic and stainless steel pipes	790 052 231		5.500
Spare belt (930 x 28 mm / 36.6 x 1.1 inch) for bench vice	790 052 247		0.100

Deburring tool

For inner and outer deburring of stainless steel, mild steel, aluminum, non-ferrous metal and plastic tubes and pipes.

Application range	Deburring tool		
Pipe OD max.	54 mm / 2.126 inch		
Pipe ID max.	10 mm / 0.394 inch		
Article	Code		kg
Deburring tool	790 052 052		0.455



Work bench, small



Collapsible work bench



Tool box



Chain pipe vice



Bench vice for plastic and stainless steel pipes



Deburring tool

Convenient renting and rent-to-own-options.

More efficiency, more reliability, more performance.

We supply equipment over a short and long term rental condition – a cost effective alternative to purchasing. We take care of our rental equipment so it is in top condition for you and we can help you to match the right rental equipment to your specific projects. Renting from Orbitalum is the ideal opportunity to try out a model you're thinking of purchasing. Ask about our convenient renting and rent-to-own-options:

» Call **+49 (0) 77 31 792-0** or e-mail to tools@orbitalum.com.

Your benefits of renting:

- Reducing need for storage
- Eliminating repair costs
- Conserving your capital
- Having the most up-to-date technology
- Minimizing down-time

Our rental and used machine service includes:

- Weekly rental charges
- Hire purchase
- Long-term rental

Easy handling – safe operation.

We as Orbitalum emphasize on the safe operation of our equipment as it has the utmost priority. We generally recommend a product safety and user training to clearly understand the proper usage of the equipment and in order to avoid any possible dangers and accidents.

We offer:

- Training on daily or weekly basis
- At any location
- Skilled trainers
- Certification after successful participation
- Fully equipped training centre in Singen
- State-of-the-art training equipment





Worldwide customer focus.

Inspiring customer service.

You can count on our comprehensive range of services. Our aim is to offer you inspiring customer service – you can measure us against this promise.

- Acclaimed state-of-the-art technology
- Competent contact partners
- Fast, comprehensive delivery service
- Reliable product support
- Practical training programs
- Certified company

Our wide range of services:

Technical support

- Repairs, maintenance, replacement
- Advance cost estimates
- On-site service
- Service training for our customers
- Cost-effective replacement devices on request

Spare parts service

- Approx. 2,000 spare parts always in stock
- State-of-the-art logistics systems

Rental/used machine service

- Weekly rental charges
- Hire purchase
- Long-term rental
- Rental with operator on request

Further support services

- Pick-up service from the customer
- Used machines with warranty

Waste disposal / environmental protection



Disposal of electrical (electronic) devices



(RL 2002/96/EC)

Electrical (electronic) devices which are marked with the symbol above, may not be disposed of with household waste in accordance to the EU directive 2002/96/EC.

By actively using the offered return and collection systems, you actively contribute to the reuse, recycling and utilisation of electrical (electronic) devices.

Electrical (electronic) used devices contain parts which must be handled selectively according to the EU directive. Separate collection and selective treatment is the basis for environment-friendly disposal and the protection of human health.

Our products that were sold to you after August 13th, 2005 are taken back and treated according to legal standards. These products have to be sent free of charge.

The return of used devices which pose a health or safety risk for human beings due to contamination during use may be refused.

The legally compliant disposal of electrical (electronic) devices that were placed on the market before August 13th, 2005 are in the responsibility of the end-user.



Returning of batteries

Some of our products work with batteries. Batteries which are marked with the symbol above may not be disposed of together with household waste according to the applicable EU directive 91/157/EEC.

With batteries containing hazardous substances, the chemical symbol for the heavy metal content is indicated below the waste bin.

Cd = Cadmium
Hg = Mercury
Pb = Lead

Service hotline: +49 (0) 77 31 792-789

»» www.orbitalum.com

worldwide | service + sales.
complete solutions. one source.

Contact:

Orbitalum Tools GmbH
E.H. Wachs Sales, Rentals & Service Centre Europe

Josef-Schuettler-Str. 17
78224 Singen, Germany
Tel. +49 (0) 77 31 792-0
Fax +49 (0) 77 31 792-524
tools@orbitalum.com
www.orbitalum.com



Certified according to
ISO 9001:2008

EN 790 700 000_00 (03.2012)



precision.
power.
simplicity.